

Wohn

PROGRAMME

ULTIMA
MASSIV KIEFER

BUTLER
MASSIV KIEFER

IVERSEN INTERIØR

made in denmark



KIEFER MASSIV SCHWARZ/LACKIERT

Modell Nr.: A206AZ

Breite: 50 cm x Höhe: 89,2 cm x Tiefe: 41,5 cm



KIEFER MASSIV SCHWARZ/LACKIERT/BORDEAUX

Modell Nr.: A504AD

Breite: 113,0 cm x Höhe: 78,5 cm x Tiefe: 41,5 cm

Ultima

TOTAL FLEXIBEL!

Das grösste und vielseitigste Kommodenprogramm auf dem Markt.

- Alle Kommoden werden aufgebaut geliefert
- 18 Oberflächen
- 8 Fußformen
- 14 Griffvarianten
- 5 Türvarianten
- In diversen Breiten und Höhen





KIEFER MASSIV SCHWARZ/LACKIERT & GELAUGT/GEÖLT

Modell Nr.: A806AC

Breite: 176,0 cm x Höhe: 89,2 cm x Tiefe: 41,5 cm



KIEFER MASSIV GRAU/LACKIERT & GELAUGT/GEÖLT

Modell Nr.: A405AC

Breite: 92,0 cm x Höhe: 88,1 cm x Tiefe: 41,5 cm



KIEFER MASSIV WEISS/LACKIERT & GELAUGT/GEÖLT

Modell Nr.: A605AD

Breite: 134 cm x Höhe: 79,6 cm x Tiefe: 41,5 cm



KIEFER MASSIV SCHWARZ/LACKIERT & GELAUGT/GEÖLT

Modell Nr.: A606AM

Breite: 134,0 cm x Höhe: 89,2 cm x Tiefe: 41,5 cm

DIE ULTIMA PHILOSOPHIE

ULTIMA in Kiefer ist aus massivem Kiefernholz aus der Region Darlarna hergestellt. Dieses Gebiet ist für sein gutes Kiefernholz bekannt. Die Philosophie von ULTIMA ist, **moderne Möbel allen zugänglich zu machen.** Dies wird durch anderes Denken und neues Bewusstsein für Kosten und Umwelt erreicht. Bei ULTIMA können Sie zwischen **mehr als 1000 Standardmodellen** wählen. Diese Flexibilität gibt Ihnen die Möglichkeit, alle Wünsche zu erfüllen.



KIEFER MASSIV WEISS/LACKIERT & SCHWARZ/GRAU

Modell Nr.: A305AC

Breite: 71,0 cm x Höhe: 84,1 cm x Tiefe: 41,5 cm



KIEFER MASSIV SCHWARZ/LACKIERT

Modell Nr.: S408AA

Breite: 92,0 cm x Höhe: 108,4 cm x Tiefe: 41,5 cm

BITTE WÄHLEN SIE:

7 Breiten

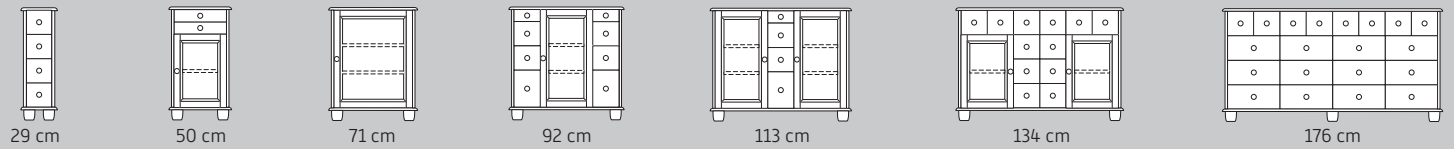

18 Höhen

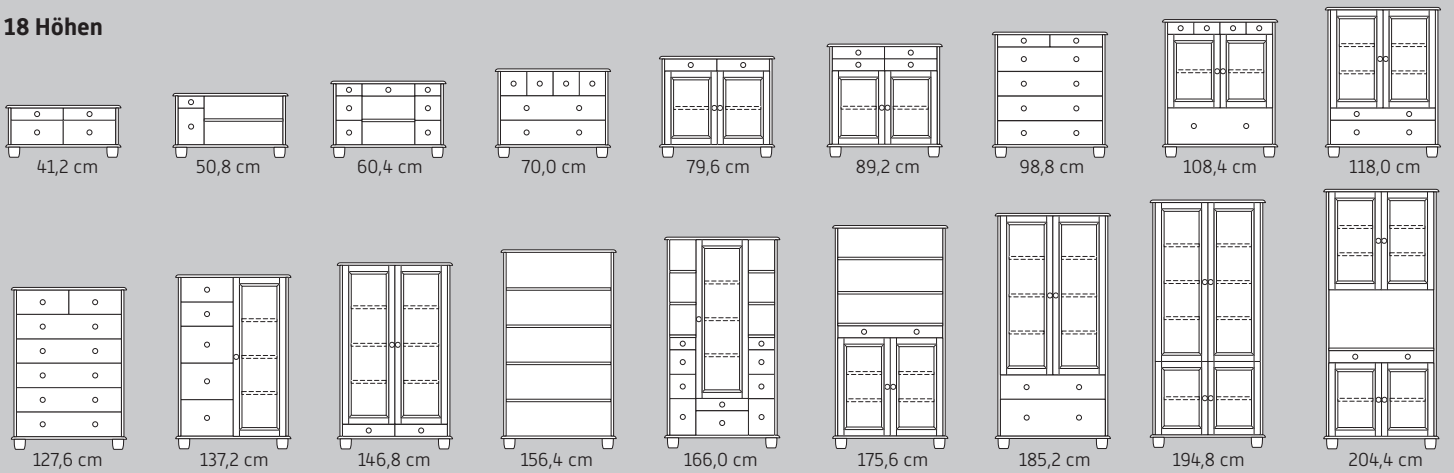

Oberflächenbehandlungen



Farben

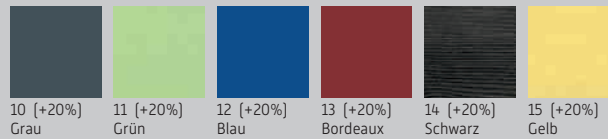

Deck- und Bodenplatte

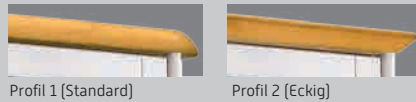

Böden



Füsse



Griffe



* Aufpreis - siehe Seite 35

Türen



Farbige Glasfronten

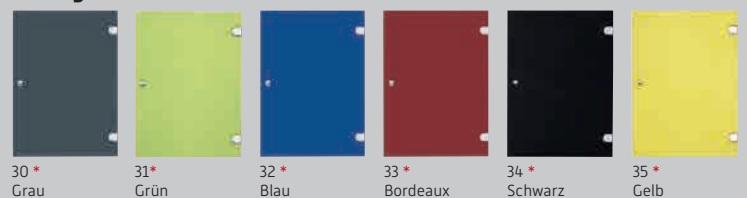

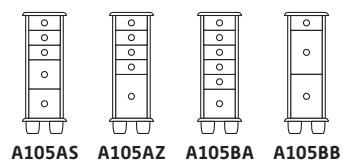
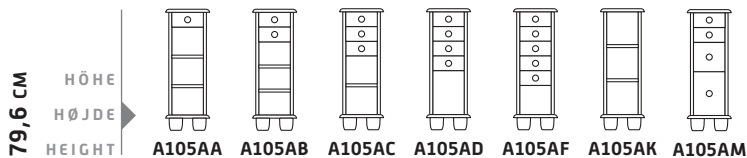
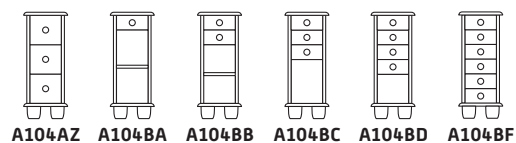
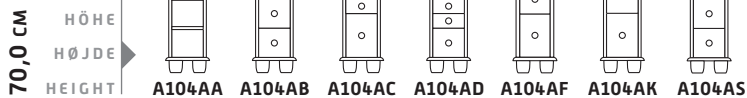
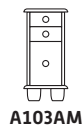
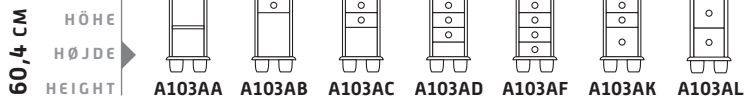
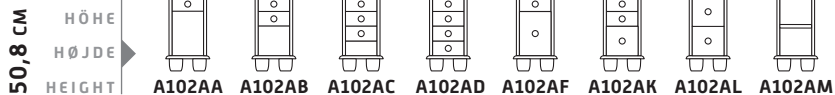
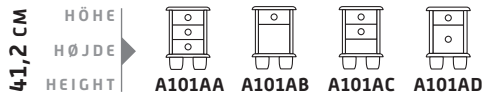

BREITE 1 = 29 CM | KOMMODEN

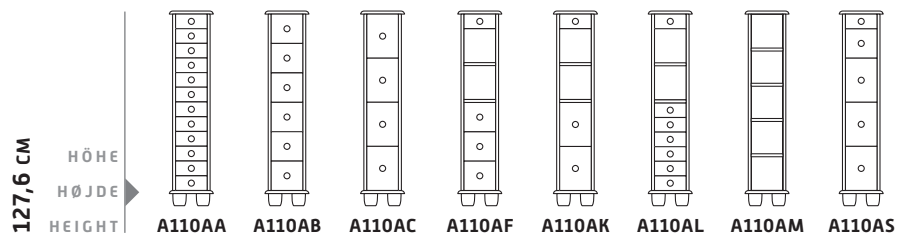
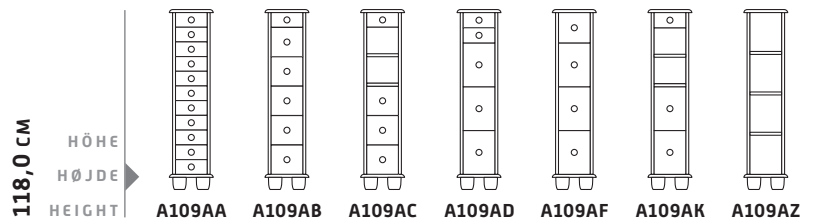
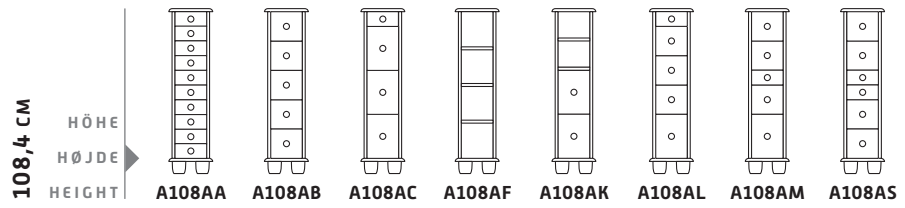
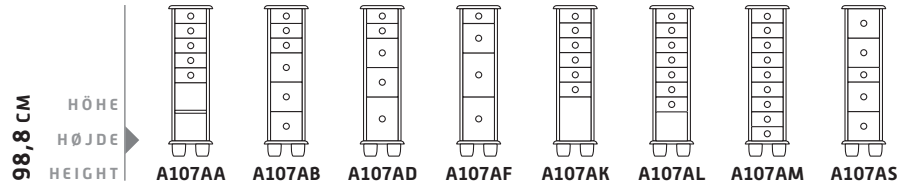
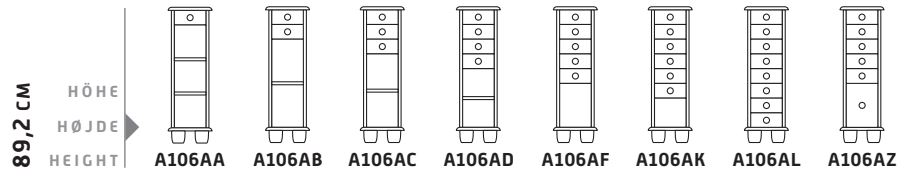

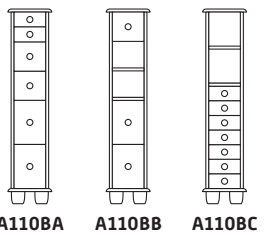
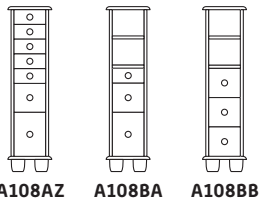
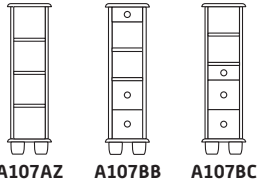
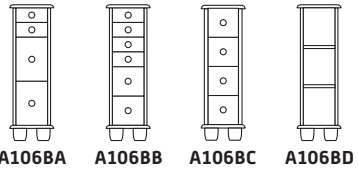

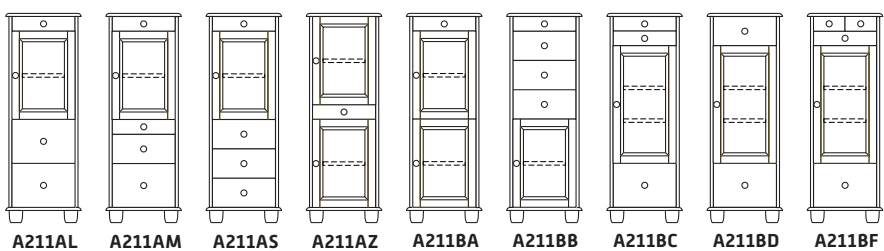
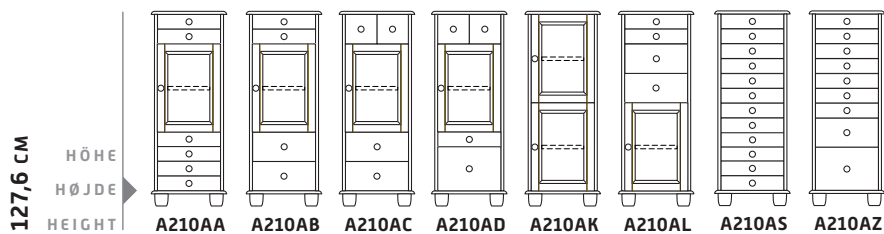
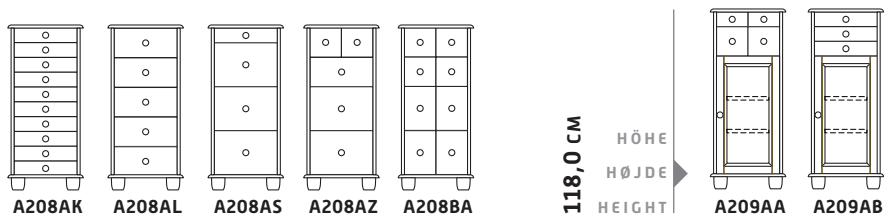
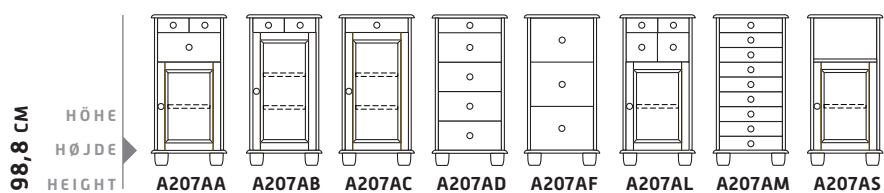
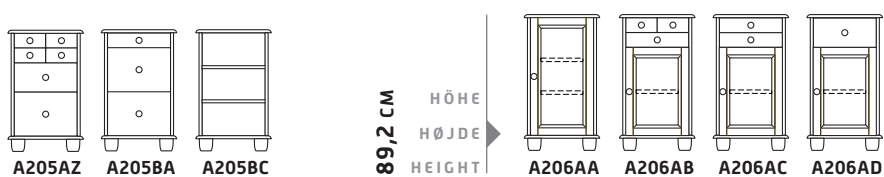
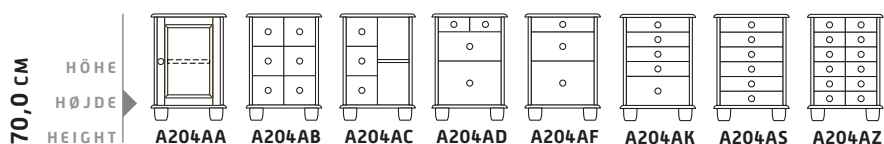
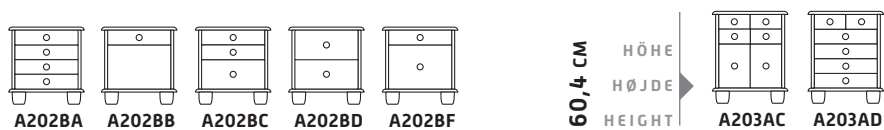
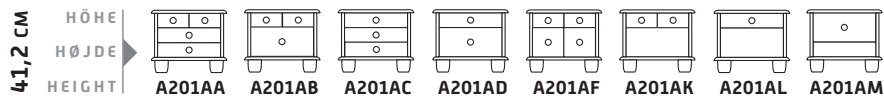

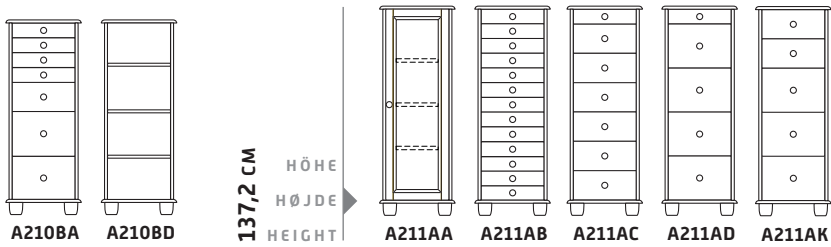
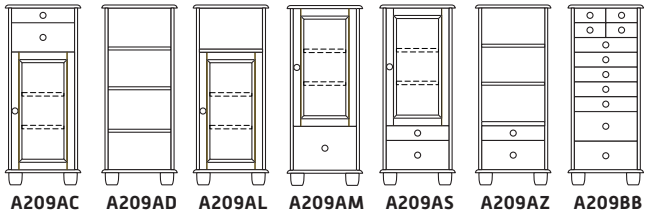
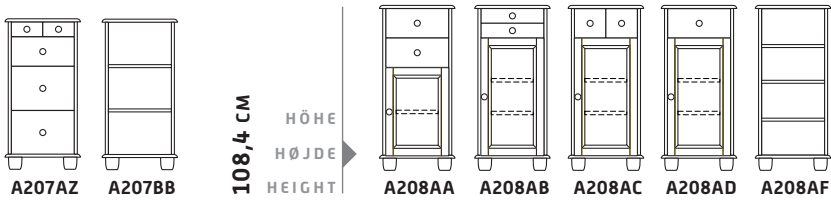
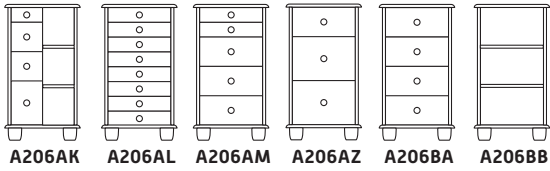
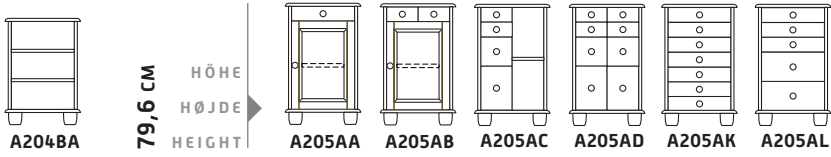
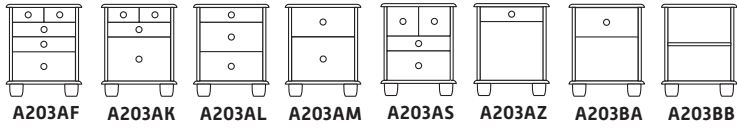
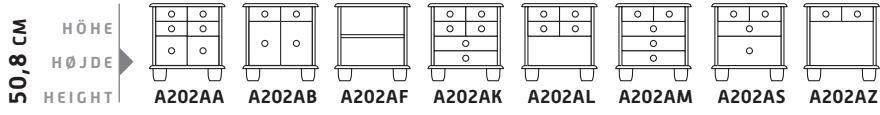

BREITE 2 = 50 CM | KOMMODEN

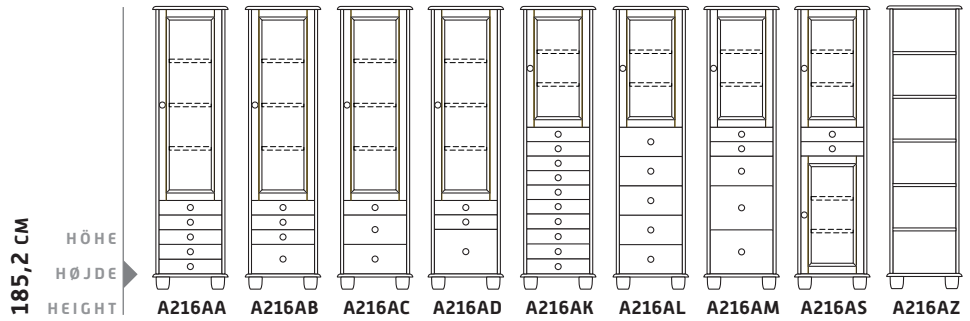
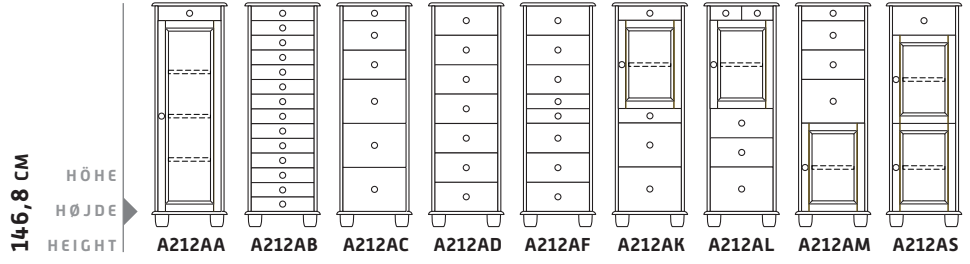

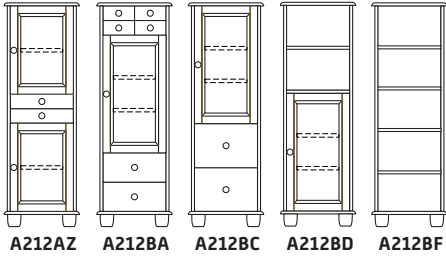

166,0 CM
HÖHE
HØJDE
HEIGHT

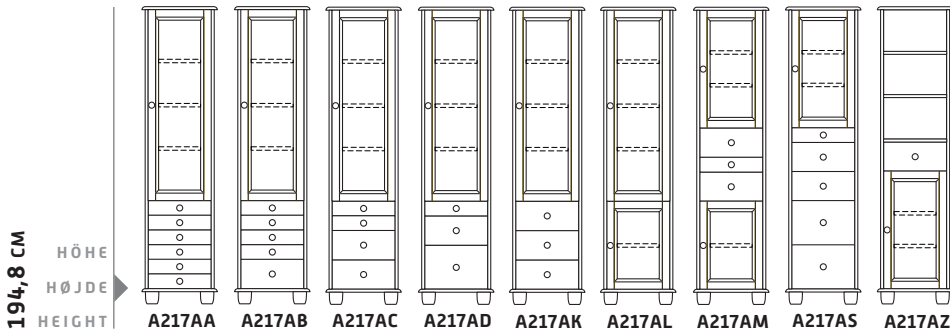
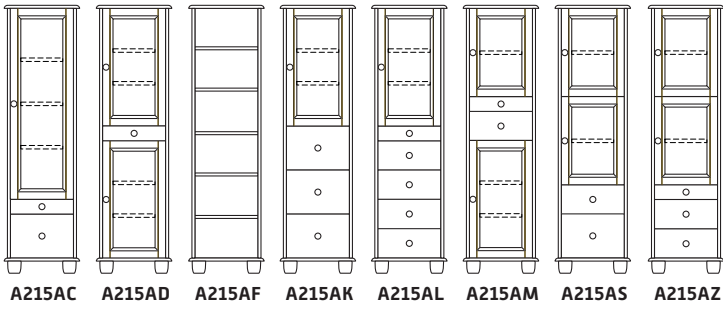
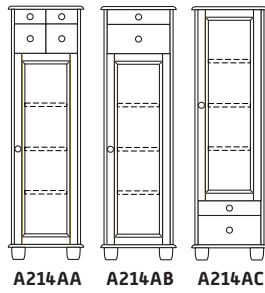

194,8 CM
HÖHE
HØJDE
HEIGHT

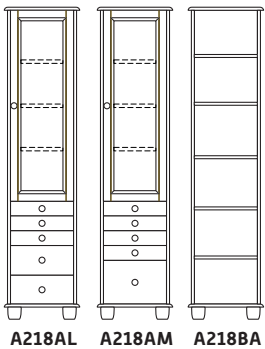

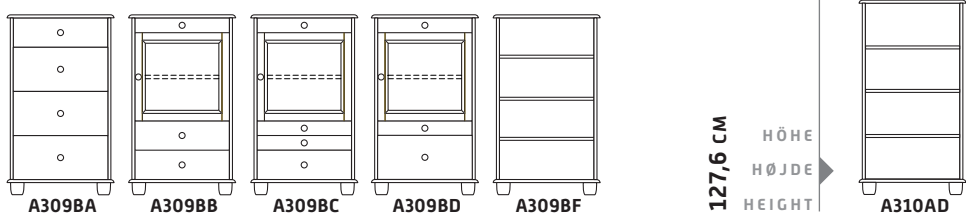
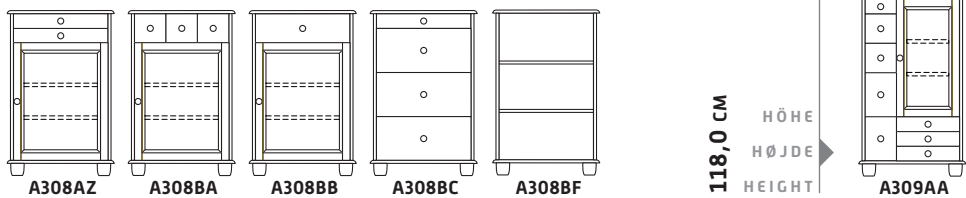
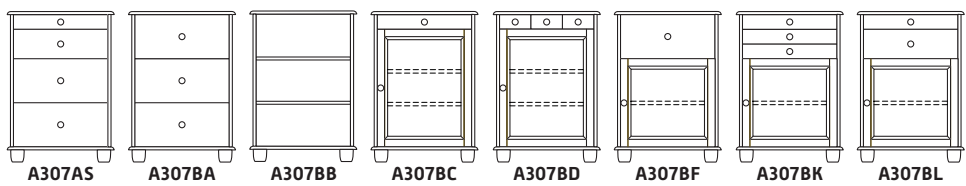
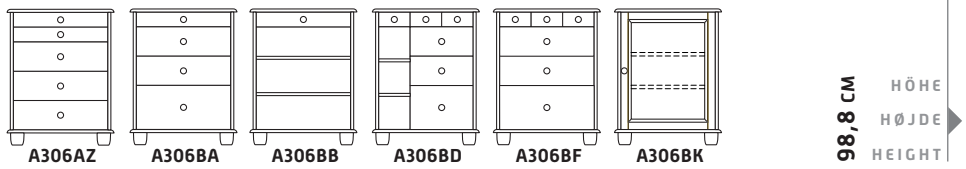
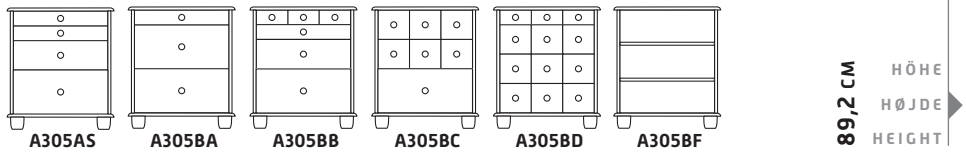
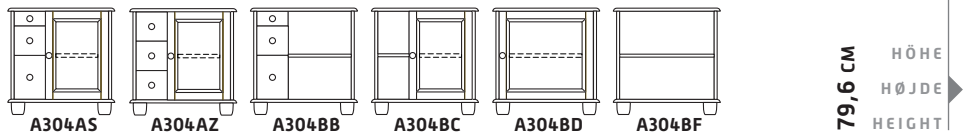
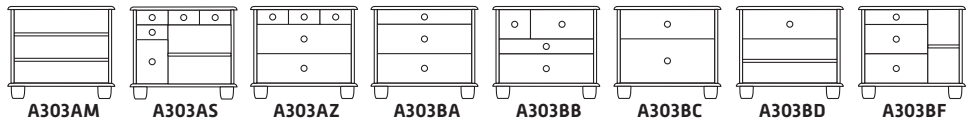
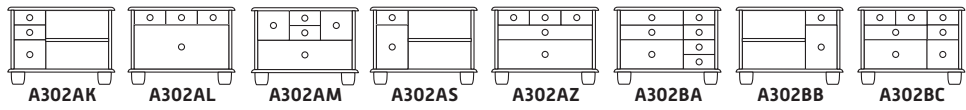
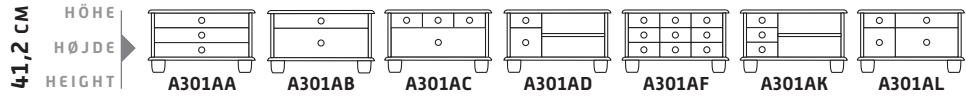

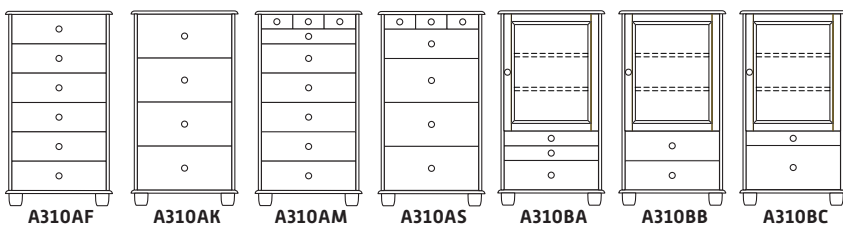
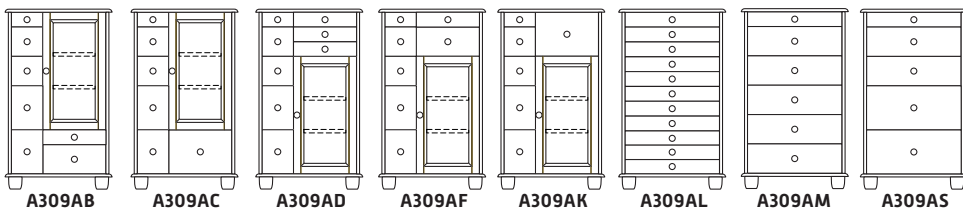
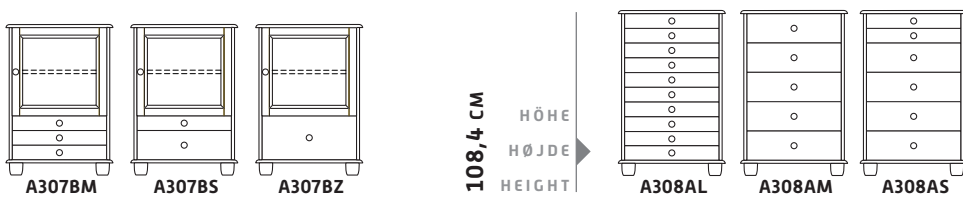
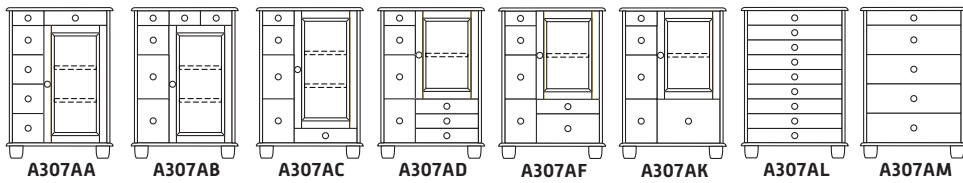
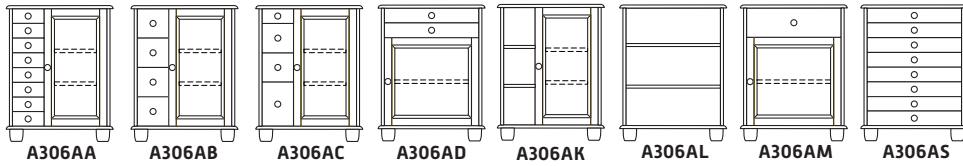
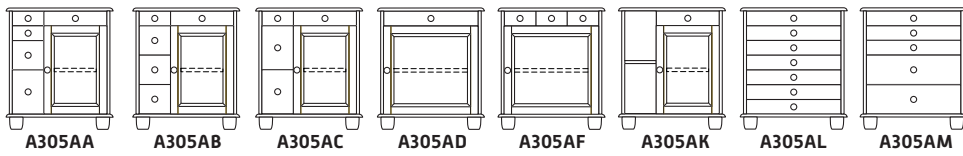
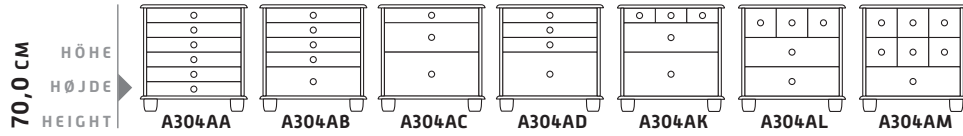
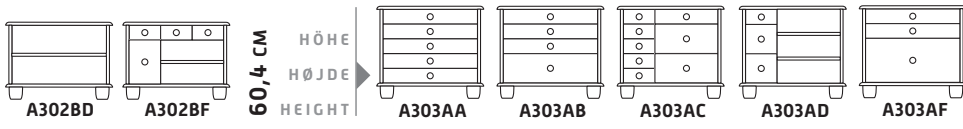
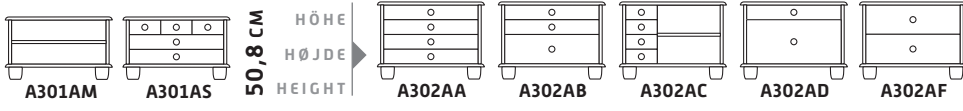

BREITE 3 = 71 CM | KOMMODEN

137,2 CM
HÖHE
HØJDE
HEIGHT

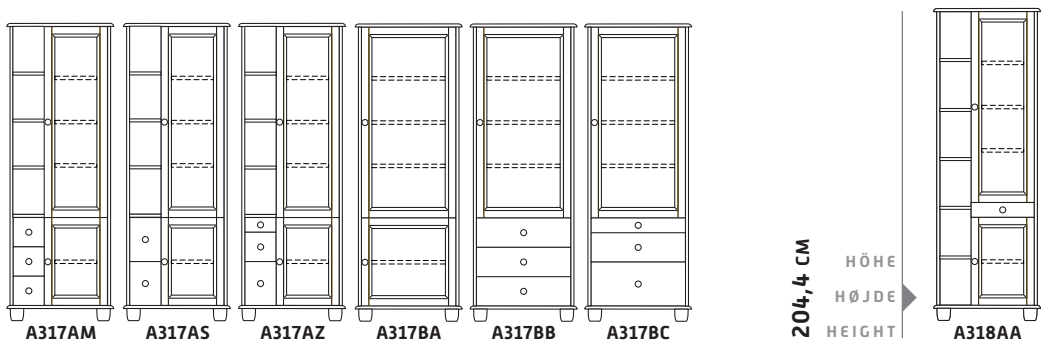
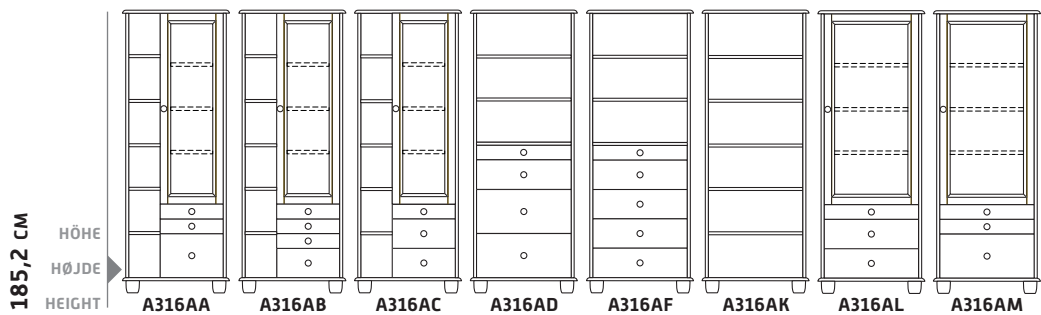
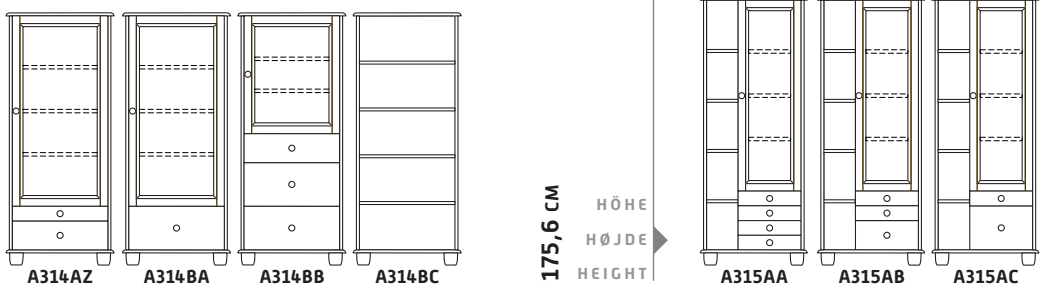
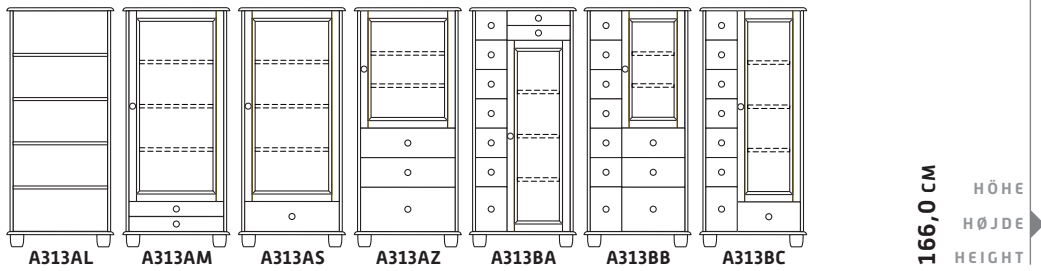
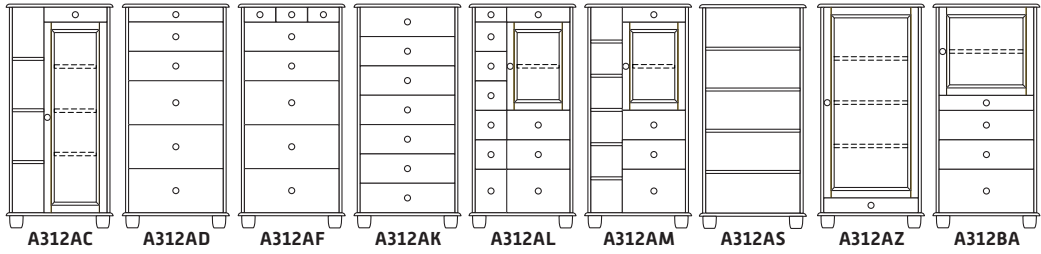
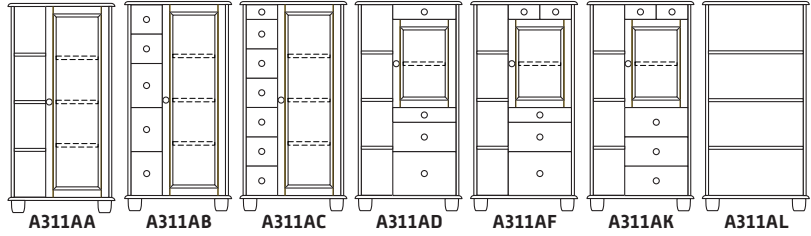

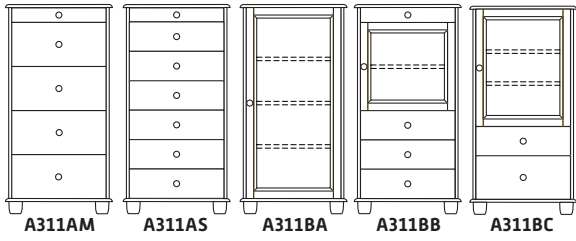

146,8 CM

HÖHE
HØJDE
HEIGHT

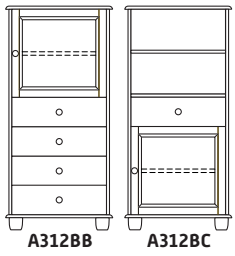
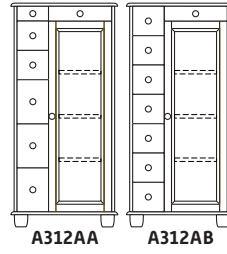

156,4 CM

HÖHE
HØJDE
HEIGHT

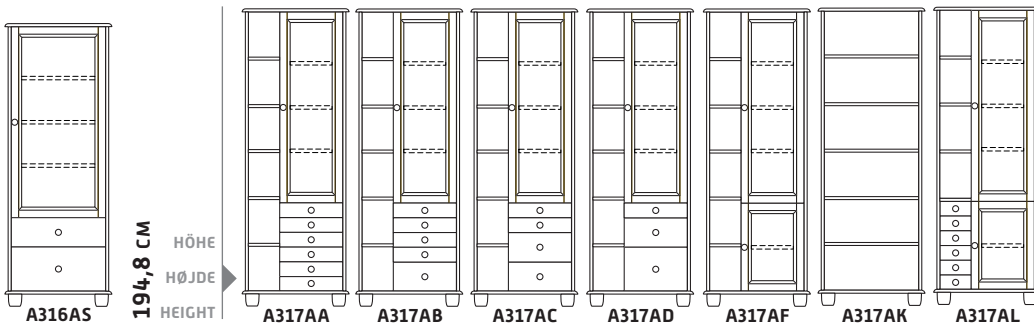
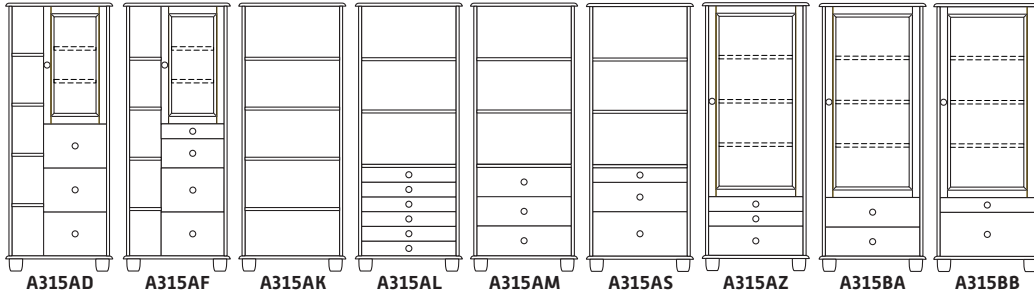
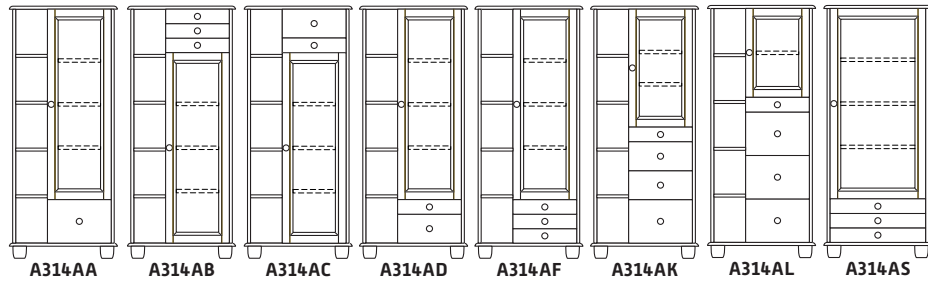
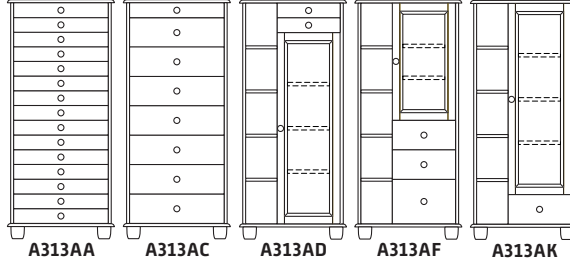

194,8 CM

HÖHE
HØJDE
HEIGHT

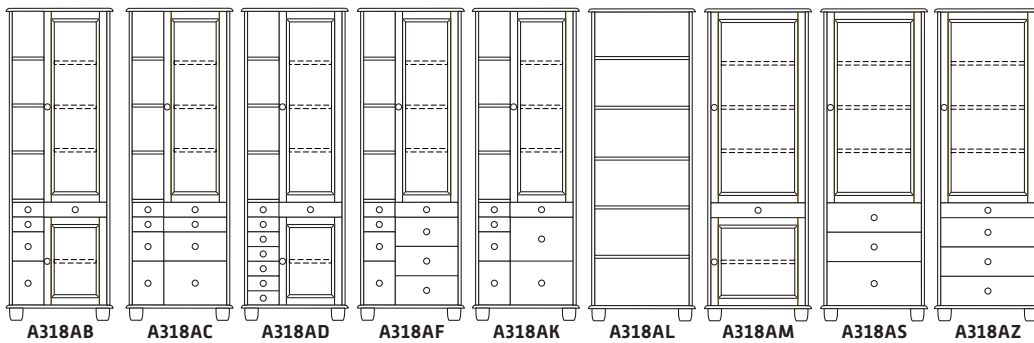



TIEFE
DYBDE
DEPTH

41,5 CM + 50,3 CM

Bei Tiefe 50,3 cm der erste
Buchstabe A mit C umtauschen!
Z.B. A401AA = 41,5 cm / C401AA = 50,3 cm

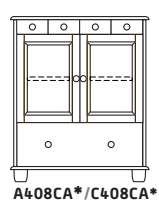
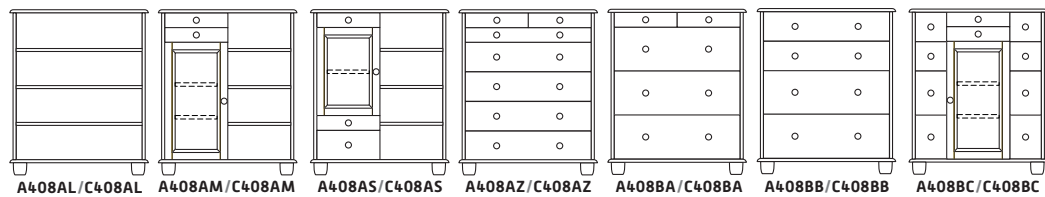
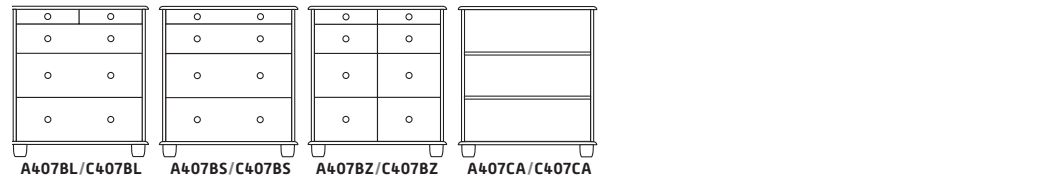
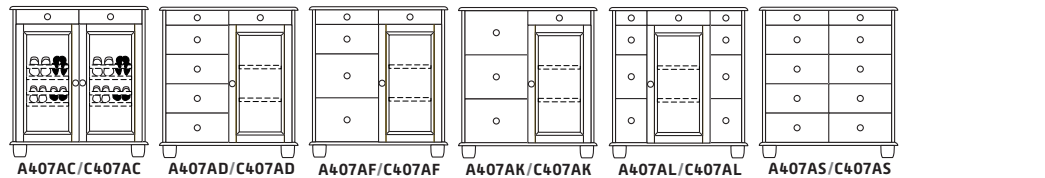
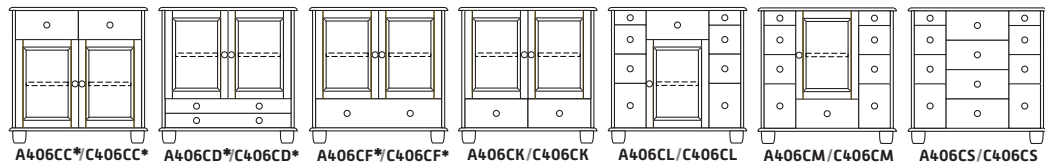
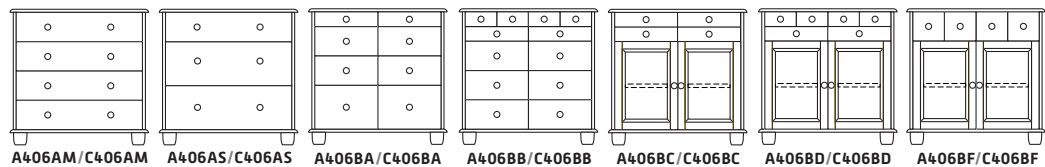
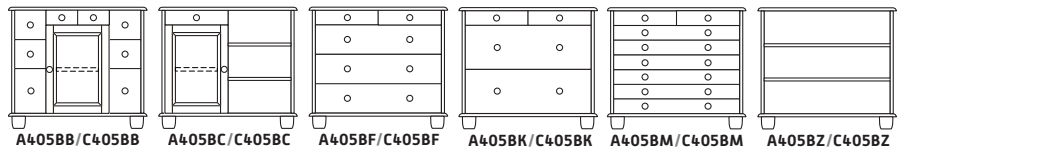
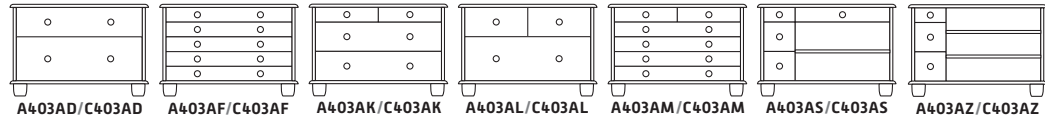
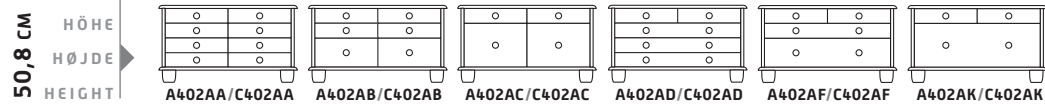

Wickelaufsätze

- BxTxH
 555A: 94x65x20
 555B: 94x72x20
 555C: 94x65x30,5
 555D: 94x72x30,5
 555G: 94x72x48,5



- auch in Tiefe 50,3 cm erhältlich · Extra: Wickelaufsätze

BREITE 4 = 92 CM | KOMMODEN

BREITE
BREDE
WIDTH

92 CM

* Durchgehender Boden / Bøden
* Gennemgående hylde / hylder
* Full width shelf / shelves

118,0 CM
HÖHE
HØJDE
HEIGHT

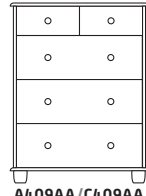

A409AA/C409AA

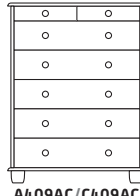

A409AC/C409AC

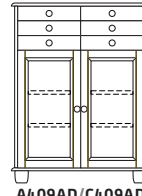

A409AD/C409AD

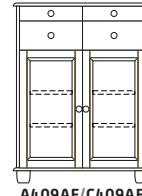

A409AF/C409AF

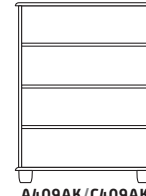

A409AK/C409AK

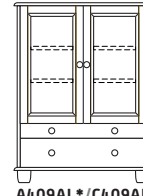

A409AL*/C409AL*



A410AK/C410AK

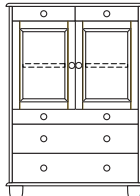

A410AL*/C410AL*

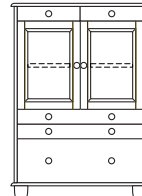

A410AM*/C410AM*

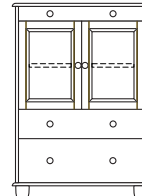

A410AS*/C410AS*

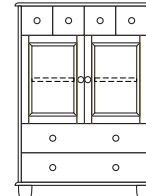

A410AZ*/C410AZ*

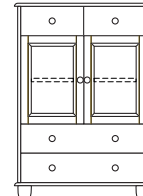

A410BA*/C410BA*

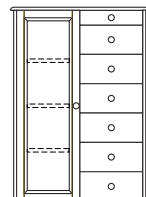

A411AL/C411AL

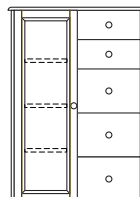

A411AM/C411AM

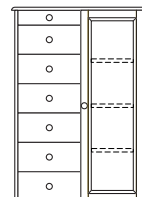

A411AZ/C411AZ

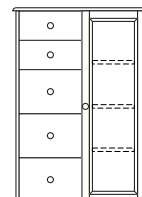

A411BA/C411BA

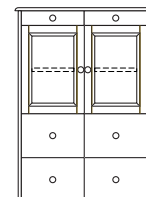

A411BC/C411BC

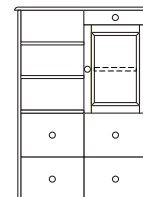

A411BD/C411BD

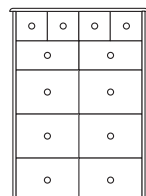

A411CC/C411CC



A411CD/C411CD

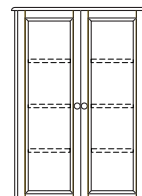

A411CF*/C411CF*



A412AA/C412AA

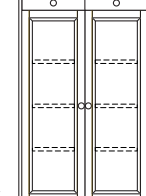

A412AB/C412AB

146,8 CM
HÖHE
HØJDE
HEIGHT

156,4 CM
HÖHE
HØJDE
HEIGHT

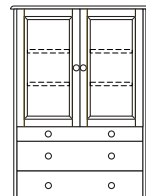

A413AA*/C413AA*

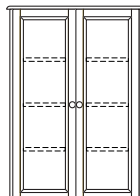

A413AB/C413AB

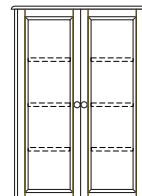

A413AC/C413AC

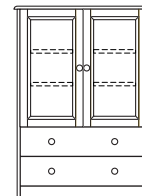

A413AD*/C413AD*



A413AF/C413AF



A413AA*/C413AA*

166,0 CM
HÖHE
HØJDE
HEIGHT

156,4 CM
HÖHE
HØJDE
HEIGHT

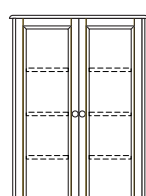

A414AM*/C414AM*



A415AA*/C415AA*

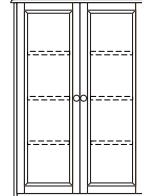

A415AB*/C415AB*

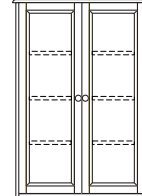

A415AC*/C415AC*

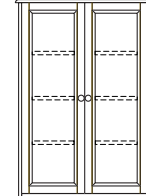

A415AD*/C415AD*

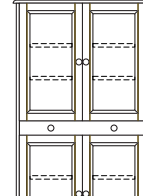

A415AD*/C415AD*

175,6 CM
HÖHE
HØJDE
HEIGHT

194,8 CM
HÖHE
HØJDE
HEIGHT

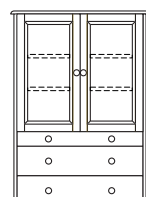

A417AA*/C417AA*

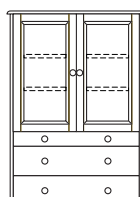

A417AB*/C417AB*



A417AC/C417AC

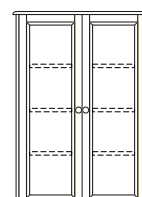

A417AD*/C417AD*

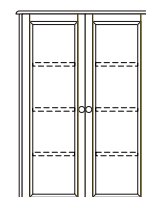

A417AF*/C417AF*

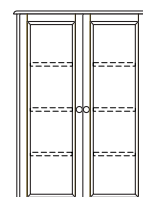

A417AK*/C417AK*

TIEFE
DYBDE
DEPTH

41,5 CM + 50,3 CM

Bei Tiefe 50,3 cm der erste
Buchstabe A mit C umtauschen!
Z.B. A401AA = 41,5 cm / C401AA = 50,3 cm

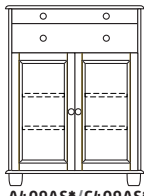
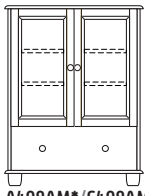

127,6 CM
HÖHE
HØJDE
HEIGHT

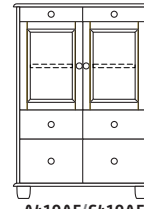
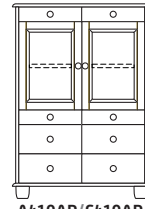
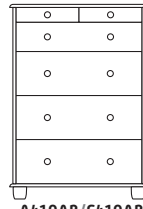
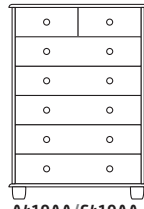

A409AM*/C409AM*

A409AS*/C409AS*

A410AA/C410AA

A410AB/C410AB

A410AD/C410AD

A410AF/C410AF

137,2 CM
HÖHE
HØJDE
HEIGHT

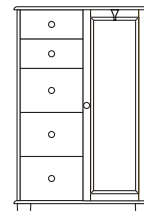
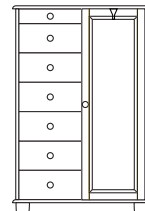
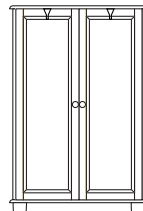
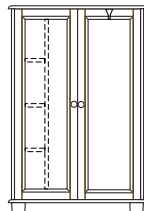
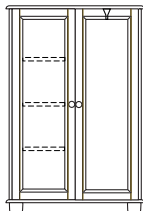
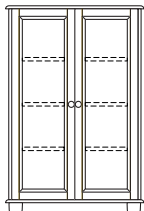

A411AA/C411AA

A411AB/C411AB

A411AC/C411AC

A411AD/C411AD

A411AF/C411AF

A411AK/C411AK

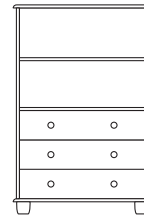
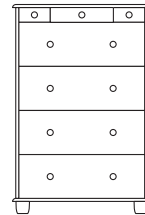
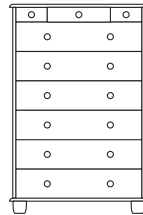
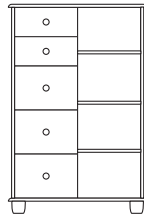
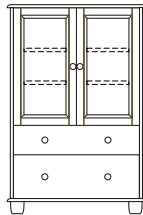
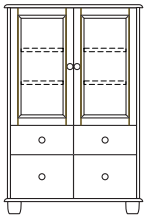
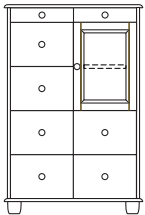

A411BF/C411BF

A411BK/C411BK

A411BL*/C411BL*

A411BM/C411BM

A411BS/C411BS

A411BZ/C411BZ

A411CB/C411CB

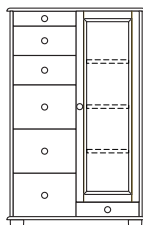
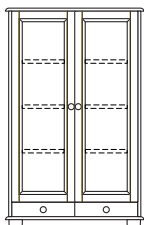
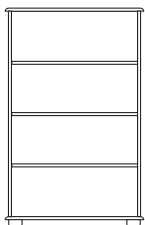

A412AC/C412AC

A412AD/C412AD

A412AF/C412AF

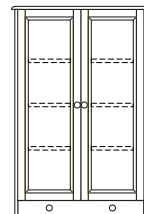
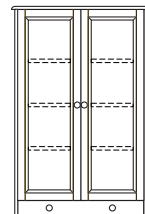
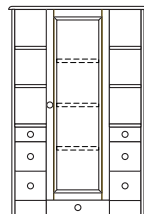
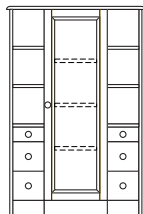

A414AA*/C414AA*

A414AB*/C414AB*

A414AC/C414AC

A414AD/C414AD

A414AF/C414AF

A414AK*/C414AK*

A414AL*/C414AL*

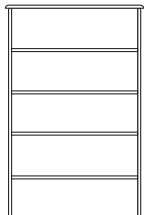
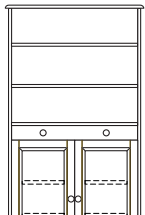

A415AF*/C415AF*

A415AK/C415AK

185,2 CM
HÖHE
HØJDE
HEIGHT

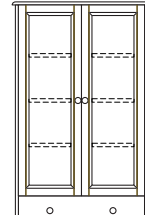
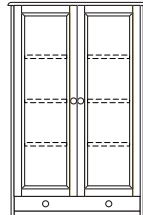

A416AA*/C416AA*

A416AB*/C416AB*

A416AC/C416AC

204,4 CM
HÖHE
HØJDE
HEIGHT

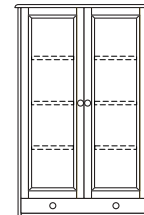
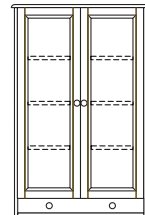
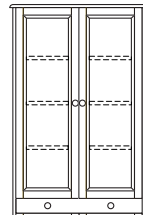
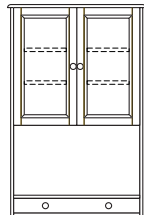
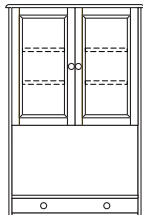
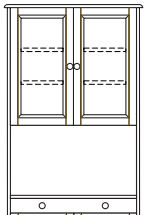

A418AA*/C418AA*

A418AB*/C418AB*

A418AC*/C418AC*

A418AD*/C418AD*

A418AF*/C418AF*

A418AK*/C418AK*

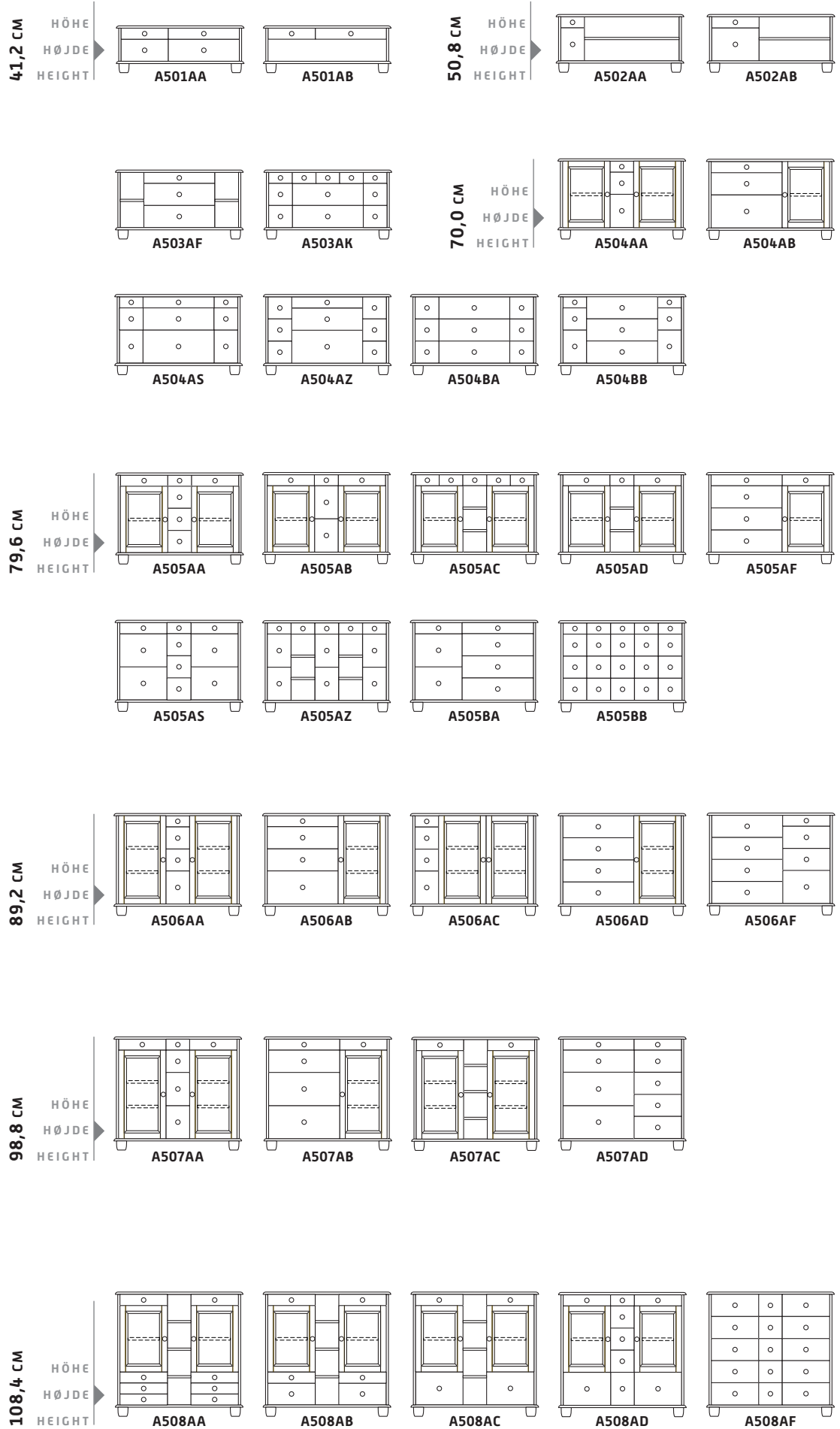

60,4 CM
HÖHE
HØJDE
HEIGHT

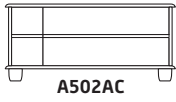

A502AC

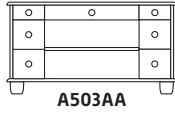

A503AA

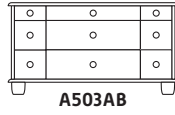

A503AB

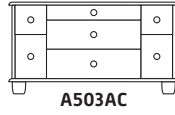

A503AC

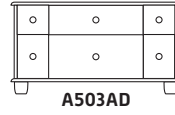

A503AD

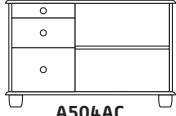

A504AC



A504AD



A504AF

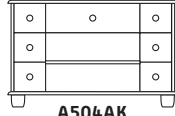

A504AK



A504AL

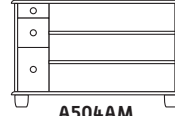

A504AM

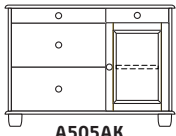

A505AK

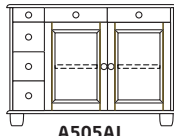

A505AL

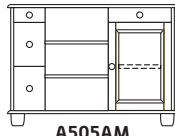

A505AM

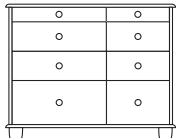

A506AK

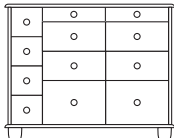

A506AL

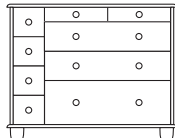

A506AM

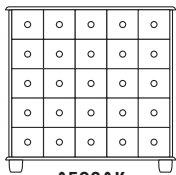

A508AK

BREITE 5 = 113 CM | KOMMODEN

118,0 CM

HÖHE
HØJDE
HEIGHT

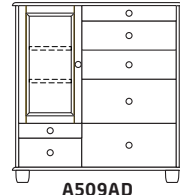
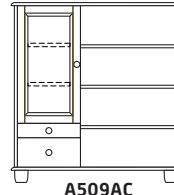
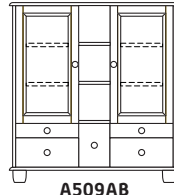
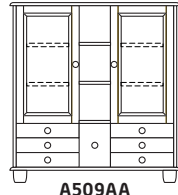

127,6 CM

HÖHE
HØJDE
HEIGHT

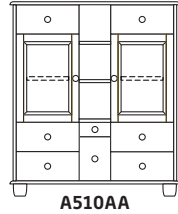

137,2 CM

HÖHE
HØJDE
HEIGHT

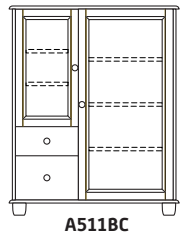
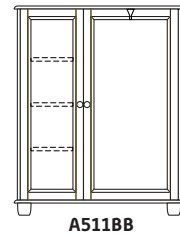
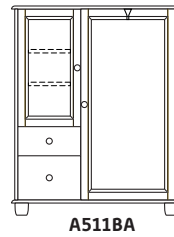
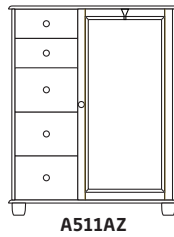
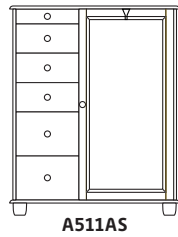
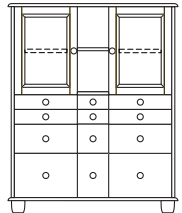
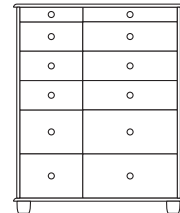
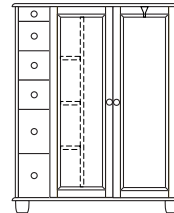
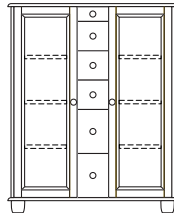
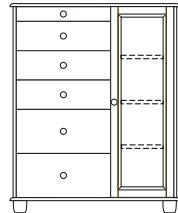

156,4 CM

HÖHE
HØJDE
HEIGHT

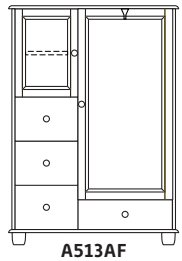
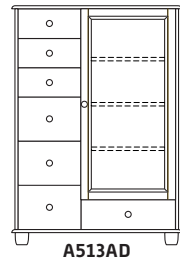
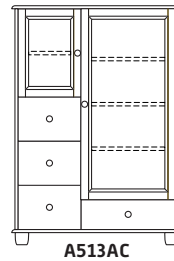
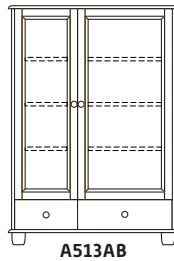
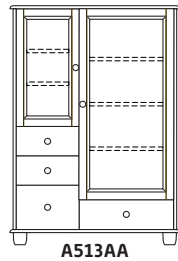

204,4 CM

HÖHE
HØJDE
HEIGHT

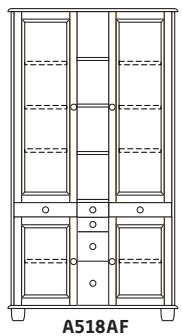
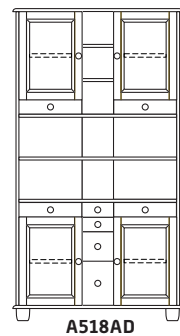
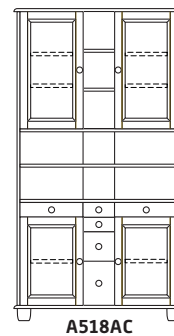
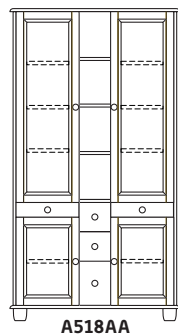

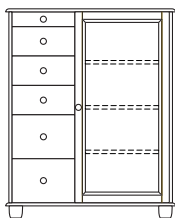

A511AL

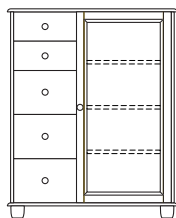

A511AM

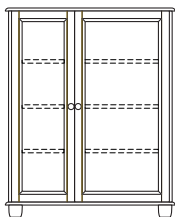

A511BD

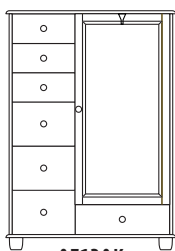

A513AK

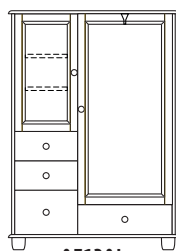

A513AL

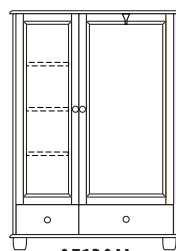

A513AM

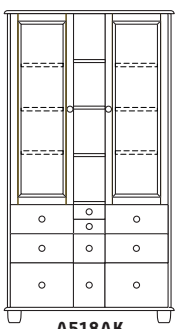

A518AK

50,8 CM
HÖHE
HØJDE
HEIGHT

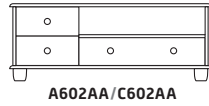

A602AA/C602AA

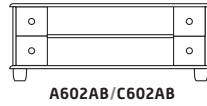

A602AB/C602AB

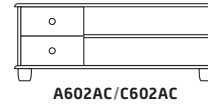

A602AC/C602AC

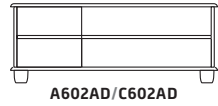

A602AD/C602AD

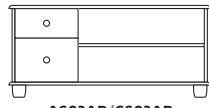

A603AD/C603AD

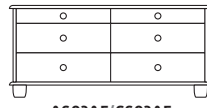

A603AF/C603AF

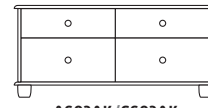

A603AK/C603AK

70,0 CM
HÖHE
HØJDE
HEIGHT

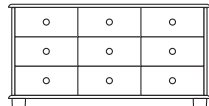

A604AK/C604AK

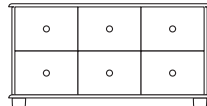

A604AL/C604AL

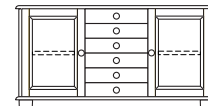

A604AS/C604AS

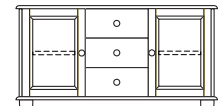

A604AZ/C604AZ

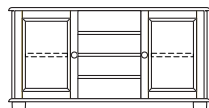

A604BK/C604BK

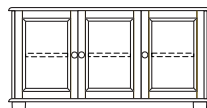

A604BL/C604BL

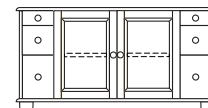

A604BM/C604BM

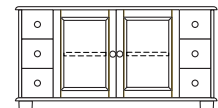

A604BS/C604BS

79,6 CM
HÖHE
HØJDE
HEIGHT

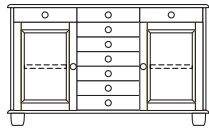

A605AA/C605AA

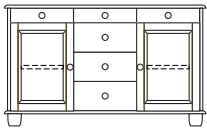

A605AB/C605AB

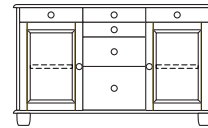

A605AC/C605AC

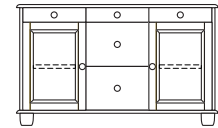

A605AD/C605AD

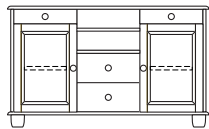

A605AZ/C605AZ

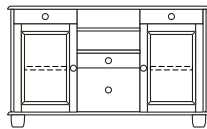

A605BA/C605BA

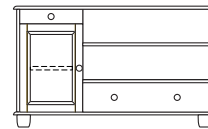

A605BB/C605BB

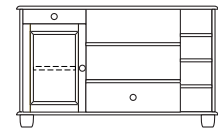

A605BC/C605BC

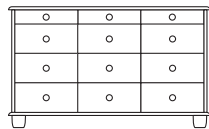

A605BK/C605BK

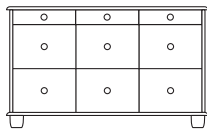

A605BL/C605BL

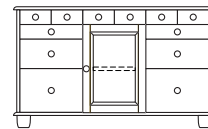

A605BM/C605BM

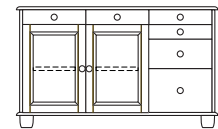

A605BS/C605BS

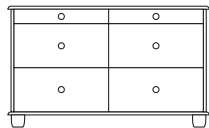

A605CF/C605CF

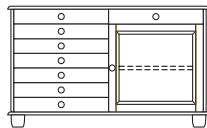

A605CK/C605CK

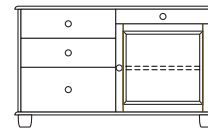

A605CM/C605CM

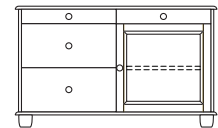

A605CS/C605CS

89,2 CM
HÖHE
HØJDE
HEIGHT

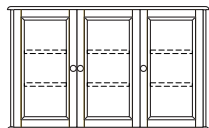

A606AA/C606AA

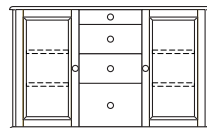

A606AB/C606AB

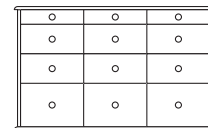

A606AC/C606AC

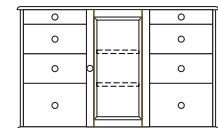

A606AD/C606AD



A606AZ/C606AZ

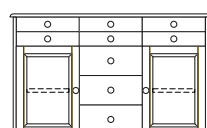

A606BA/C606BA

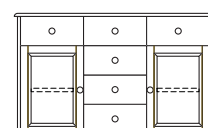

A606BB/C606BB

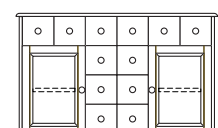

A606BC/C606BC

60,4 CM
HÖHE
HØJDE
HEIGHT

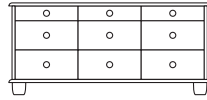

A603AA/C603AA

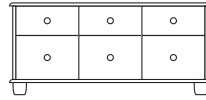

A603AB/C603AB

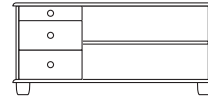

A603AC/C603AC

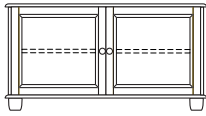

A604AA/C604AA

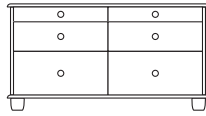

A604AB/C604AB

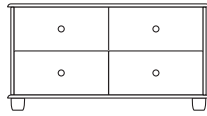

A604AC/C604AC

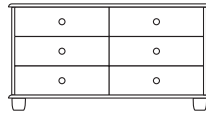

A604AD/C604AD

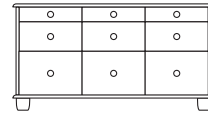

A604AF/C604AF

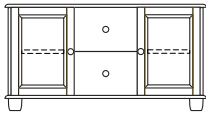

A604BA/C604BA

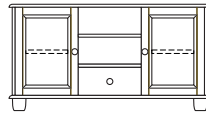

A604BB/C604BB

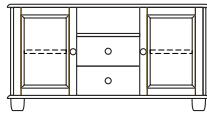

A604BC/C604BC

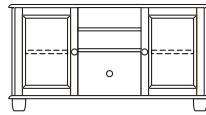

A604BD/C604BD

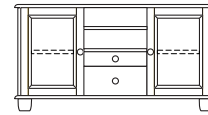

A604BF/C604BF

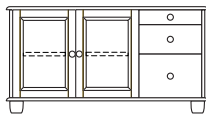

A604BZ/C604BZ

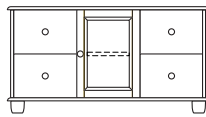

A604CA/C604CA

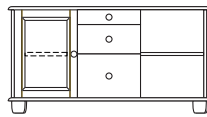

A604CB/C604CB

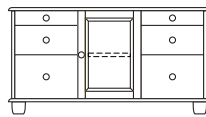

A604CC/C604CC

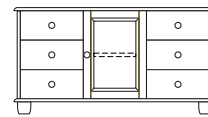

A604CD/C604CD

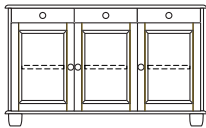

A605AF/C605AF

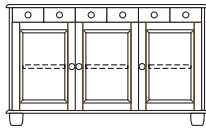

A605AK/C605AK

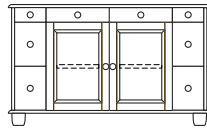

A605AL/C605AL

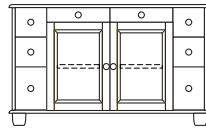

A605AM/C605AM

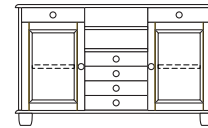

A605AS/C605AS

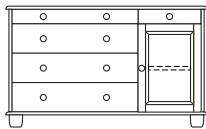

A605BD/C605BD

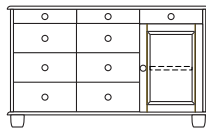

A605BF/C605BF

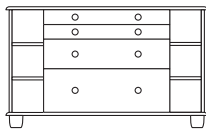

A605BZ/C605BZ

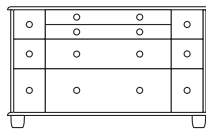

A605CA/C605CA

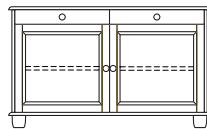

A605CB/C605CB

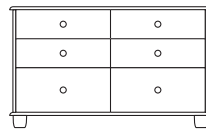

A605CD/C605CD

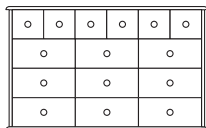

A606AF/C606AF

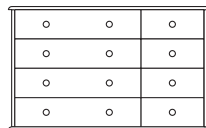

A606AK/C606AK

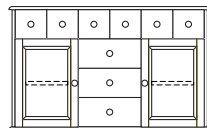

A606AL/C606AL

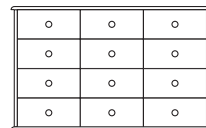

A606AM/C606AM

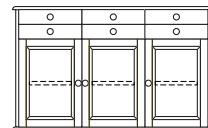

A606AS/C606AS

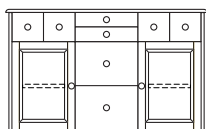

A606BD/C606BD

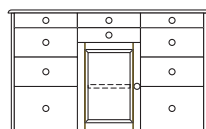

A606BF/C606BF

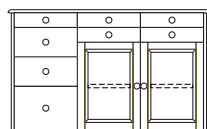

A606BK/C606BK

- auch in Tiefe 50,3 cm erhältlich

BREITE 6 = 134 CM | KOMMODEN

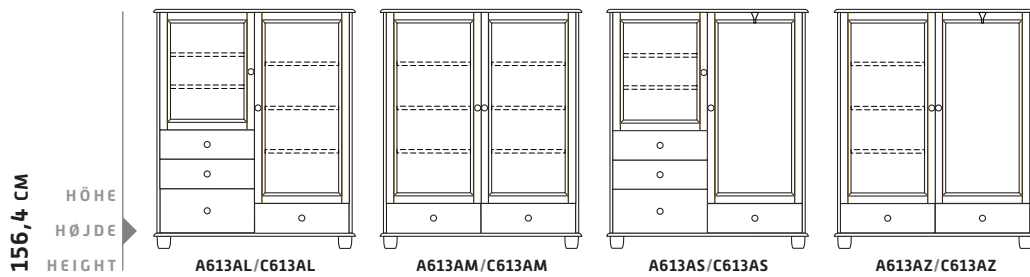
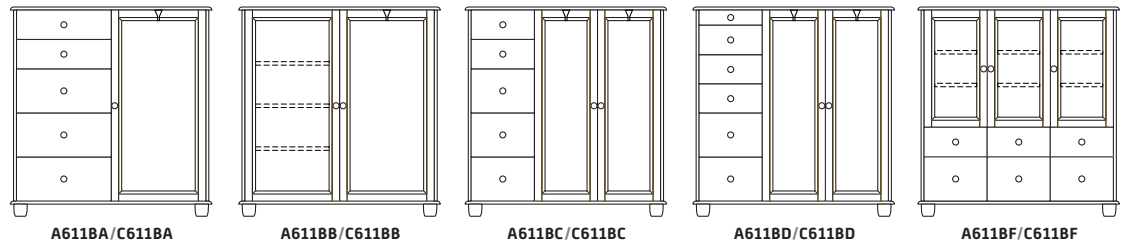
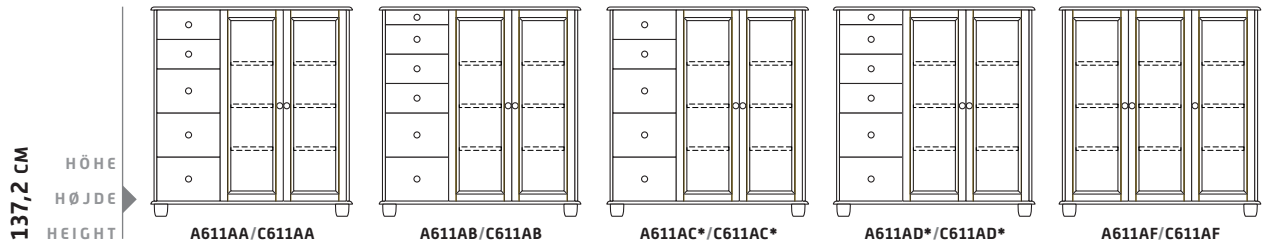
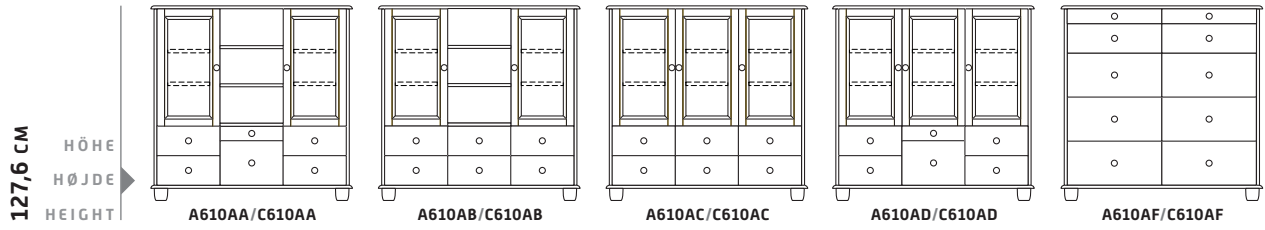

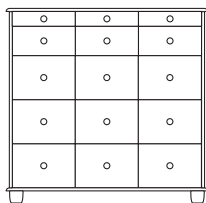

A610AK/C610AK

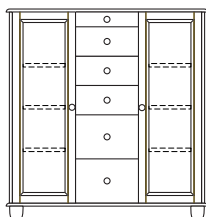

A611AK/C611AK

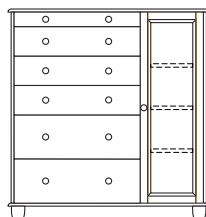

A611AL/C611AL

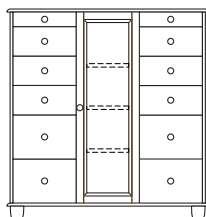

A611AM/C611AM

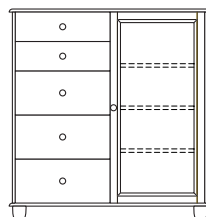

A611AS/C611AS

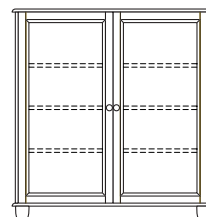

A611AZ/C611AZ

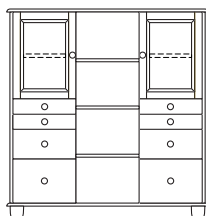

A611BK/C611BK

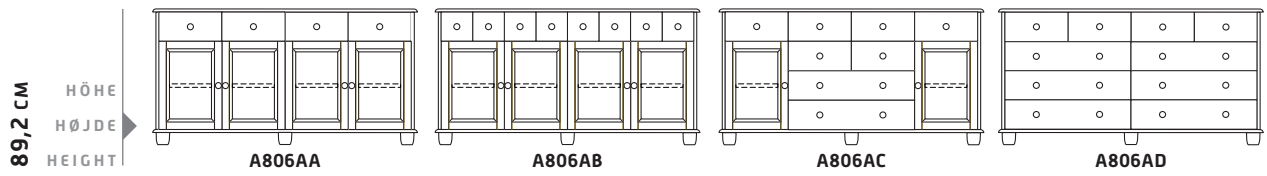
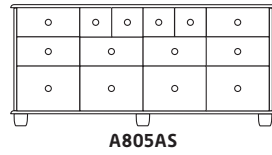
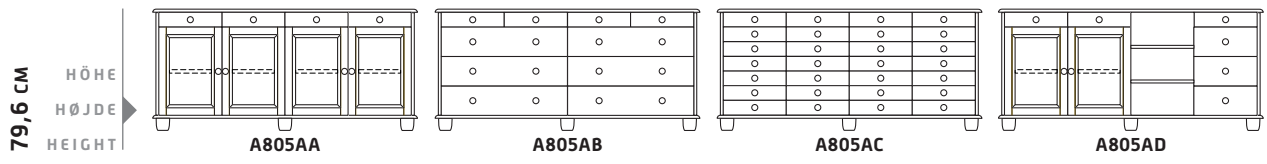

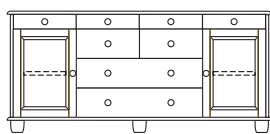

A805AF

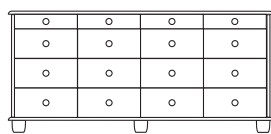

A805AK

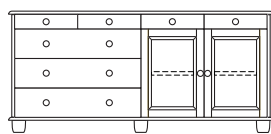

A805AL

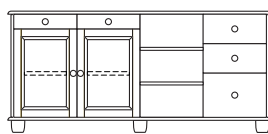

A805AM

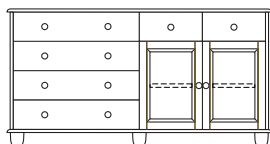

A806AF

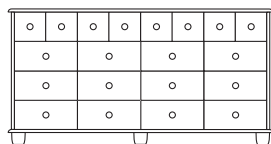

A806AK

BREITE 8 = 176 CM | KOMMODEN / HÄNGESCHRÄNKE / KÖRBE Seite 30

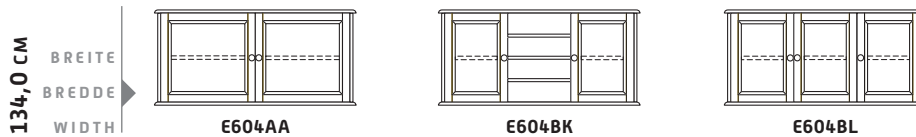
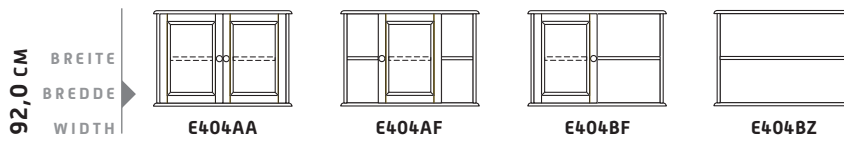
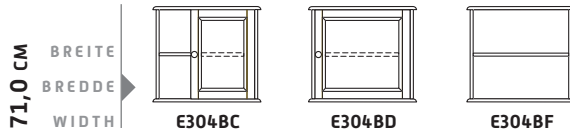
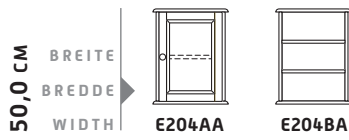

KÖRBE Material: Wasserhyazinthe

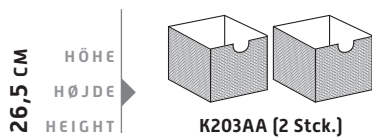
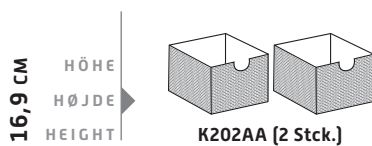

ACHTUNG

Bei den Kommoden können 2 Größen der Schubladen mit Körben ohne Aufpreis ersetzt werden. Siehe Skizze.

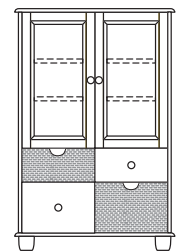

A411BK / C411BK

SEKRETÄRE

HÖHE
HØJDE
HEIGHT

108,4 CM

TIEFE
DYBDE
DEPTH

41,5 CM

92,0 CM
BREITE
BREDDE
WIDTH



S408AA



S408AB

ECKUNTERSCHRÄNKE

HÖHE
HØJDE
HEIGHT

89,2 CM

72/72 CM
BREITE
BREDDE
WIDTH

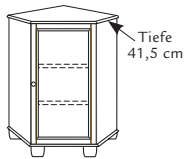

T406AA

62/62 CM
BREITE
BREDDE
WIDTH

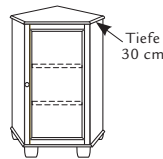

T406AB

ECKOBERSCHRANK

HÖHE
HØJDE
HEIGHT

105,6 CM

62/62 CM
BREITE
BREDDE
WIDTH

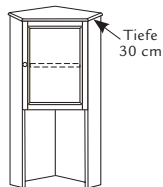

T406BA

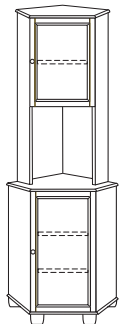

T406BA/
T406AA

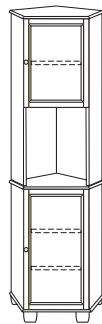

T406BA/
T406AB

INFORMATION ZUR KIEFER

Die Nordische Kiefer wird überwiegend nördlich vom Polarkreis geschlagen. Dort herrschen tiefe Temperaturen die das Wachstum des Baumes verlangsamen und somit für ein härteres Holz sorgen. Die Kiefer nimmt Laugen und Öle unterschiedlich auf. Abgerundete Kanten z.B. saugen die Lauge viel kräftiger als glatte Oberflächen, weil sie offenporiger sind. Weiss lackierte Oberflächen können sich mit der Zeit farblich ändern und die Äste werden sichtbar. Holz als Naturprodukt „lebt“. Im Laufe der Zeit können Farbveränderungen und Rissbildung entstehen, verstärkt durch Licht- und Sonneneinstrahlung oder starke Lichtquellen. Ein möglichst konstantes Raumklima ist für Massivholz das wichtigste. Dabei ist eine Raumtemperatur von 19 – 21° und eine Luftfeuchtigkeit von 45 bis 55% zu beachten.

ERSATZTEILE – PREISE UND MASSE

EINLEGEBÖDEN

Bei dem Ultima-Programm gibt es 4 Breiten und 2 Tiefen von Einlegeböden

Bezeichnung des Einlegebodens	Masse [cm] BxT	Masse [cm] BxT
B1	18,9 x 35,5	18,9 x 44,3
B2	39,9 x 35,5	39,9 x 44,3
B3	60,9 x 35,5	60,9 x 44,3
B4	81,9 x 35,5	81,9 x 44,3

TÜREN

Bei dem Ultima-Programm gibt es 2 Breiten und 3 Höhen von Türen

Bezeichnung der Tür Breite=B, Höhe=H	Masse [cm] BxH
B2, H1	41,6 x 57,3
B2, H2	41,6 x 76,5
B2, H3	41,6 x 124,5
B3, H1	62,6 x 57,3
B3, H2	62,6 x 76,5
B3, H3	62,6 x 124,5

SCHUBLADEN

Bei dem Ultima-Programm gibt es 4 Breiten und 3 Höhen von Schubladen

Bezeichnung der Schublade	Masse [cm] BxHxT
B1, H1	20,6 x 9,3 x 36,0
B1, H2	20,6 x 18,9 x 36,0
B1, H3	20,6 x 28,5 x 36,0
B2, H1	41,6 x 9,3 x 36,0
B2, H2	41,6 x 18,9 x 36,0
B2, H3	41,6 x 28,5 x 36,0
B3, H1	62,6 x 9,3 x 36,0
B3, H2	62,6 x 18,9 x 36,0
B3, H3	62,6 x 28,5 x 36,0
B4, H1	83,6 x 9,3 x 36,0
B4, H2	83,6 x 18,9 x 36,0
B4, H3	83,6 x 28,5 x 36,0

GRIFFE

Bei dem Ultima-Programm gibt es 14 verschiedene Griffe

Bezeichnung der Griffe
A1, B1, C1, D1, E1, F1, G1, H1, J1, L1
M1, N1, O1, P1

FÜSSE

Bei dem Ultima-Programm gibt es 8 verschiedene Fussvarianten

Bezeichnung der Füße
Kügelfüße (K1/K2), Sockel, Shaker, Nostalgie, Butler
Metallbeine, Rollen

Alle Kommoden werden aufgebaut geliefert (nur Füße und Griffe müssen noch montiert werden)

MATERIAL

Holz: Schwedisches Kiefernholz
 Holzstärke: 20 mm (Seiten 30 mm)
 Teleskopschienen: GS-Prüfung nach DIN 68 858
 Leim: Umweltfreundlich nach DIN Norm
 Pflegeöl: Umweltfreundlich nach DIN Norm
 Lackierung: UV-Lack auf Wasserbasis.
 Umweltfreundlich nach DIN-Norm

OBERFLÄCHENBEHANDLUNG:

Nr. 16 Weiss/lackiert
 Nr. 17 Kirsche/lackiert
 Nr. 18 Natur/lackiert
 Nr. 19 Gelaugt/geölt
 Nr. 20 Gelaugt/lackiert
 Nr. 21 Natur/geölt
 Nr. 22 Bernstein/geölt
 Nr. 23 Bernstein/lackiert
 Nr. 24 Unbehandelt
 Nr. 25 Cuba/lackiert
 Nr. 26 Provence/lackiert
 Nr. 27 Doppelt Weiss/lackiert

FARBEN:

Nr. 10 Grau
 Nr. 11 Grün
 Nr. 12 Blau
 Nr. 13 Bordeaux
 Nr. 14 Schwarz
 Nr. 15 Gelb

FARBIGE GLASFRONTEN:

Nr. 30 Grau
 Nr. 31 Grün
 Nr. 32 Blau
 Nr. 33 Bordeaux
 Nr. 34 Schwarz
 Nr. 35 Gelb

Bitte beachten Sie, dass es einen Farbunterschied zwischen farbigem Glas und farbigem Holz gibt.

MODELLVARIANTEN:

K = Kugelfüße S = Sockel F = Shakerfüße N = Nostalgiesockel*
 B = Metallbeine R = Rollen U = Butlersockel*
 T = Holztür G = Glastür (Füllungstür) M = Spiegeltür V = Glastür
 D = Serie 1 (Ultima Standard) L = Serie 2 (Ultima Landhaus)

*ACHTUNG!

Der Nostalgiesockel und der Butlersockel sind bei Kommoden in Breite 29 cm nicht montierbar!

Standard: Holztüren, Holzböden, Kugelfüße und Serie 1

Alternativ: Es ist jedoch auch möglich, ULTIMA mit Glastüren, Füllungstüren in Glas, Glasböden, Spiegeltüren, Sockel, Shakerfüße, Nostalgiesockel, Metallbeine, Rollen, Butlersockel oder Serie 2 (Landhaus) zu bekommen.

ACHTUNG!

Wenn Sie andere Varianten als Standard wünschen, muss dies ausdrücklich aus Ihrer Bestellung hervorgehen – SONST liefern wir immer mit Holztüren, Holzböden, Kugelfüßen und Serie 1.

Wenn Füllungstüren in Glas (G), Glastüren (V) oder Spiegeltüren (M) angegeben werden, werden alle Türen mit Glas/Spiegel geliefert. Sie können aber auch Holz- und Glas/Spiegeltüren bei einem Modell kombinieren, dies muss aber ausdrücklich aus Ihrer Bestellung hervorgehen.

ACHTUNG!

Die Höhenangaben verstehen sich inkl. Standard Füße/Sockel von 8 cm.

Wenn Sie sich für andere Füße entscheiden, beachten Sie bitte den Höhenunterschied.

Serie 1/Ultima Standard

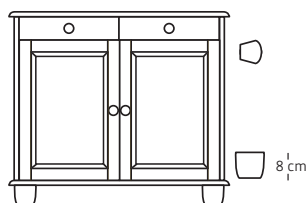

Serie 2/Landhaus

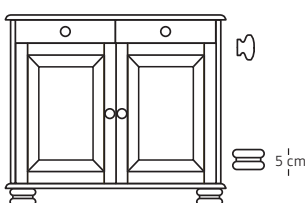

Achtung!

Der Höhenunterschied beträgt 3 cm zwischen Standard Kugelfüßen und Landhaus Kugelfüßen.
 Die Ultima Landhaus Serie ist 3 cm niedriger als die Standard Serie!

UMWELT-VERTRÄGLICHKEIT

Wir beglückwünschen Sie zu Ihrem neuen Kiefernholzmöbelstück. Es wurde aus Holz hergestellt, das aus umweltverträglicher Forstwirtschaft in Skandinavien stammt.

Wir möchten hier gern erzählen, was wir gemacht haben, und was Sie tun können, damit das Möbelstück die Umwelt so wenig wie möglich belastet.

Die Umweltpolitik

Es gehört zu unserer Umweltpolitik, die Umwelt immer zu berücksichtigen, so daß die Belastungen sowohl für die Umwelt als auch bei der Herstellung so gering wie möglich ausfallen, indem wir uns fortlaufend um Verbesserungen bemühen. Unser Umweltbewußtsein drückt sich dadurch aus, daß wir Materialien auswählen und Arbeitsvorgänge so gestalten, daß das zum Nutzen unserer Kunden, unserer Mitarbeiter und der Umwelt ist.

Woraus bestehen die Möbel?

Das Standardsortiment an Kiefernholzmöbeln ist groß, doch werden alle Modelle praktisch aus den gleichen Materialien hergestellt. Im Durchschnitt sieht der Materialeinsatz für ein Möbelstück wie nachfolgend aufgeführt aus:

Teil:	Gewicht in %	Datenblatt vorhanden	
Kiefernholz	88	ja	W
Pappverpackung	6	ja	W
Sperrholz	2	ja	W
Leim	1	ja	NW
Metall	1	ja	WV
Oberflächen- behandlung	<1	ja	NW
Kunststoff	<1	nein	WV
Glas	<1	ja	WV

Materialanteil:

Nach Entsorgung weiterverwertbar (W) 96%

Wiederverwendbar (WV) <3%

Nicht weiterverwertbar (NW) <2%

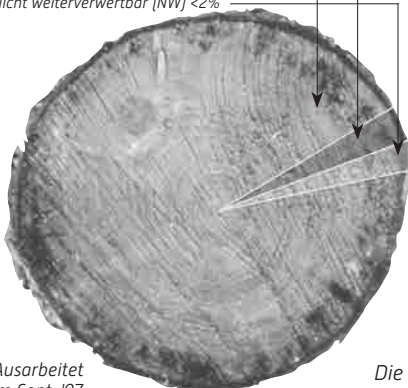

Ausarbeitet
im Sept. '97

Einhaltung von gesetzlichen Anforderungen

Formaldehyd ist aus den meisten Verarbeitungsgängen bei der Herstellung verbannt, und wo ein Einsatz unerlässlich ist, richten wir uns nach den weltweit strengsten Grenzwertfestsetzungen der deutschen E1-Norm.

Die Entsorgung der Transportverpackung wird durch Interseroh Reg. Nr. 10419 veranlasst.

Umwelt

Der Werk hält die geltenden dänischen Umweltgesetze ein und arbeitet laufend mit der staatlichen Gesundheitsvorsorge für Gewerbebetriebe und dem dänischen Arbeitsumweltdienst zusammen.

Energieeinsatz: Bis zu 38% der im Werk eingesetzten Energie stammt aus Windkraftanlagen, der Rest aus kohle- und erdgasgefeuerten E-Werken. Geheizt wird mit Fernwärme, Erdgas und unter Ausnutzung von Holzabfällen in Verbrennungsanlagen - eine Energiequelle, die kein CO₂ freisetzt.

Pflege der Möbel

Um die lange Lebensdauer der Möbel und geringstmögliche Umweltbelastung zu gewährleisten, geben wir folgende Empfehlungen:

Allgemeine Reinigung: Alle Möbel sollten nur mit einem Lappen, der nach Eintauchen in Seifenwasser oder klares Wasser ausgewrungen wurde, gewischt werden.

Pflege: Lackierte Möbel erfordern keine besondere Pflege. Mit Öl behandelte Möbel werden einmal jährlich mit Öl eingerieben - entsprechend der beigelegten Probe.

Ein guter Rat: Stellen Sie bitte keine Möbel in Naßräume oder an andere Orte, wo große Schwankungen bei Temperatur oder Luftfeuchte vorkommen. Das hat Einfluß auf die Lebensdauer und das Aussehen der Möbel.

Die Informationen wurden vom Institut DTI Træteknik überprüft.

Kiefernholzmöbel

Farben

Für die farbigen Kiefernmöbel ist eine wasserbasierte Farbe verwendet. Gewisse Farbenunterschiede, abhängig von der Struktur des Holzes, z.B. bei Äste, kommen vor, indem Holz lebendiges Material ist.

Herstellungsbereich

Materialien/Hilfsmittel: Es wird ständig an der Auswahl von Materialien gearbeitet, die weder kurz- noch langfristig gesundheitsschädlich sind.

Schwere Hebevorgänge: Die Belastung der Mitarbeiter wird durch den Einsatz von Hubeinrichtungen, Rollenförderern und Lastaufzügen - soweit möglich - überall gering gehalten.

Entlüftung: Entsprechende Einrichtungen befinden sich direkt an der Entstehungsquelle, so daß Beeinträchtigungen durch Staub und Luftzug auf ein Mindestmaß begrenzt werden.

Psychische Befindlichkeit am Arbeitsplatz:

Einflußnahme von Mitarbeitern und Ausbildung gehören als wichtige Elemente zur Sicherung des Arbeitsklimas und damit der Produktqualität sowie zum Erhalt der Umwelt.

Umgang mit Abfällen und Restmaterialien

Holzspäne werden an die spanverarbeitenden Industrie weitergegeben oder zur Energieerzeugung verwendet. Metalle, Kunststoffe, Papier usw. wird sortiert und der Wiederverwertung zugeführt. Chemikalienreste werden gesammelt und zu einer genehmigten Müllverbrennungsanlage transportiert.

Wenn das Möbelstück entsorgt werden muß...

Möbelstück: Sollte immer zerlegt werden, ehe es der Entsorgung zugeführt wird. Holz kann in genehmigten Müllverbrennungsanlagen (= neue Energie) verbrannt werden. Metall- und Kunststoffteile können wiederverwendet werden. Untersuchen Sie die konkreten Möglichkeiten vor Ort, da die Recycling-Technik ständig neuen Entwicklungen unterworfen ist.

SO BESTELLEN SIE

BEI EINER BESTELLUNG BENÖTIGEN WIR FOLGENDE INFORMATIONEN:

MODELL NR.

OBERFLÄCHENBEHANDLUNG

- Nr. 16 Weiss/lackiert (Preis +10%)
- Nr. 17 Kirsche/lackiert (Preis +10%)
- Nr. 18 Natur/lackiert
- Nr. 19 Gelaugt/geölt
- Nr. 20 Gelaugt/lackiert (Preis +10%)
- Nr. 21 Natur/geölt
- Nr. 22 Bernstein/geölt
- Nr. 23 Bernstein/lackiert (Preis +10%)
- Nr. 24 Unbehandelt
- Nr. 25 Cuba/lackiert (Preis +10%)
- Nr. 26 Provence/lackiert (Preis +10%)
- Nr. 27 Doppelt Weiss/lackiert (Preis +20%)

FUSSAUSFÜHRUNG

- Kugelfüsse (K)
- Sockel (S)
- Shakerfüsse (F)
- Nostalgiesockel (N)
- Metallbeine (B)
- Rollen (R)
- Butlersockel (U)

TÜRAUSFÜHRUNG

- Holztür (T)
- Füllungstür/Glas (G)
- Spiegeltür (M)
- Glastür (V)

DECK- UND BODENPLATTE

- Profil 1 (Standard)
- Profil 2 (Eckig)

SERIE

- Standard (D)
- Landhaus (L)

FARBIGE GLASFRONTEN

- Grau Farbe Nr. 30
- Grün Farbe Nr. 31
- Blau Farbe Nr. 32
- Bordeaux Farbe Nr. 33
- Schwarz Farbe Nr. 34
- Gelb Farbe Nr. 35

FARBEN

- Grau Farbe Nr. 10 (Preis +20%)
- Grün Farbe Nr. 11 (Preis +20%)
- Blau Farbe Nr. 12 (Preis +20%)
- Bordeaux Farbe Nr. 13 (Preis +20%)
- Schwarz Farbe Nr. 14 (Preis +20%)
- Gelb Farbe Nr. 15 (Preis +20%)

BEISPIEL:

A405AA-16-K-V-D

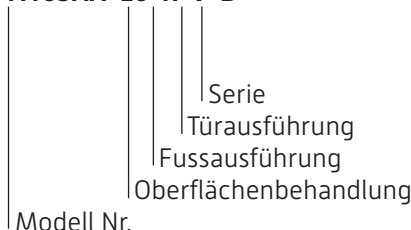

BEISPIEL EINER FARBBESTELLUNG:

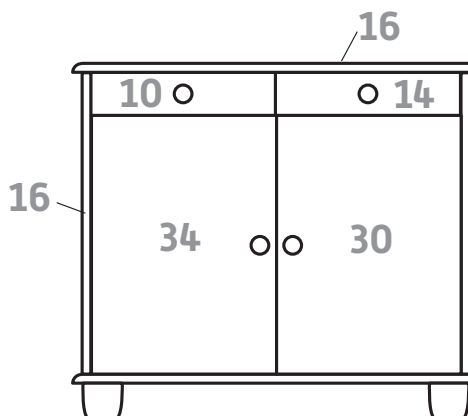

Eventuelle Farbkombination (Um Missverständnisse zu vermeiden, bitte Skizze mitschicken)

ZUSCHLAG FÜR FARBIGE GLASFRONTEN:

BREITE 41,6 CM

- Klein (Höhe 57,3 cm)
- Mittel (Höhe 76,5 cm)
- Gross (Höhe 124,5 cm)

BREITE 62,6 CM

- Klein (Höhe 57,3 cm)
- Mittel (Höhe 76,5 cm)
- Gross (Höhe 124,5 cm)

ZUSCHLAG FÜR METALLBEINE UND ROLLEN:

- Metallbeine (4 Stck.)
- Rollen (4 Stck.)

ZUSCHLAG FÜR METALLGRIFFE:

- M1, N1, O1, P1

BUTLER PROGRAMM

Folgende Oberflächenbehandlungen möglich: Natur/lackiert [18] • Gelaugt/geölt [19] • Natur/geölt [21] • Bernstein/geölt [22] • Unbehandelt [24].
Gegen 10% Aufpreis: Weiss/lackiert [16] • Kirsche/lackiert [17] • Gelaugt/lackiert [20] • Bernstein/lackiert [23] • Cuba/lackiert [25] • Provence/lackiert [26].
Gegen 20% Aufpreis: Doppelt Weiss/lackiert [27].
Standardgriff: Holz D1.

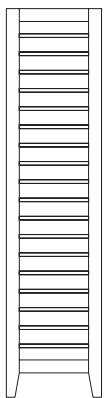

D218AA
Rippenelement
BxTxH
50x6x204,4 cm

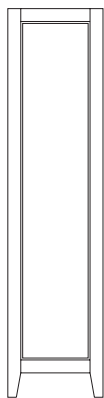

D218AB
Paneel
BxTxH
50x6x204,4 cm

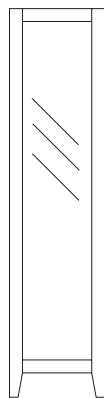

D218AC
Paneel m. Spiegel
BxTxH
50x6x204,4 cm

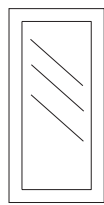

D207AA
Spiegel
BxTxH
50x6x102,2 cm

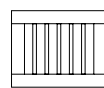

D280AA
Hutablage/Schuhrost*
BxTxH
50x40x3 cm

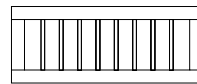

D281AA Hutablage*
BxTxH
100x40x3 cm

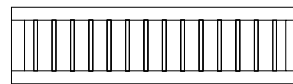

D282AA Hutablage*
BxTxH
150x40x3 cm

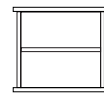

D283AA Telefonelement
BxTxH
50x29x43 cm

Obige Waren werden mit Leisten an der Wand montiert. Dadurch wird die Gesamttiefe der Ware 6 cm.

*ACHTUNG! Die Hutablagen D280AA, D281AA und D282AA sind nur zwischen 2 Butler-Paneelen/Rippen-elementen montierbar (Siehe Butler-Paket Nr. 3)

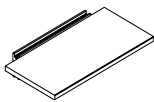

D284AA
Bodenelement
BxTxH
50x29x10 cm

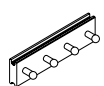

D285AA
Hakenelement
BxTxH
36x8x10 cm

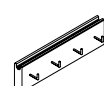

D285AB
Schlüsselement
BxTxH
36x5x10 cm

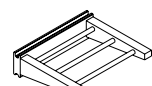

D287AA
Handtuchhalter
BxTxH
36x29x10 cm

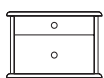

A201AD Kommode
BxTxH
50x41,5x33,2cm

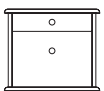

A202BF Kommode
BxTxH
50x41,5x42,8 cm

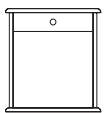

A203AZ Kommode
BxTxH
50x41,5x52,4 cm

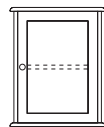

A204AA Kommode
BxTxH
50x41,5x62 cm

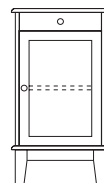

A205AA Kommode
BxTxH
50x41,5x89,2 cm

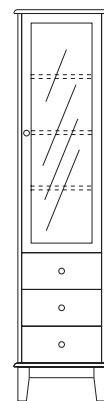

A217AK Kommode
BxTxH
50x41,5x204,4 cm

Beispiele einiger Ultima Kommoden, die sich mit BUTLER kombinieren lassen. Körbe und weitere Kommoden - siehe Ultima Übersicht.

Pakete:

Tiefenangabe inklusive Montageleisten [3 cm].
Preisvorteil im Paket 5% gegenüber den Einzelteilen.
Pakete nur wie vorgegeben.

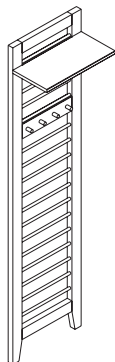

BUTLER 1
BxTxH
50x35x204,4 cm

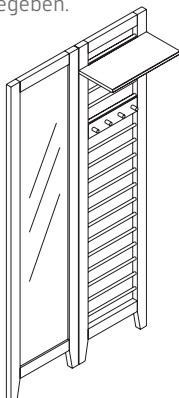

BUTLER 2
BxTxH
100x35x204,4 cm

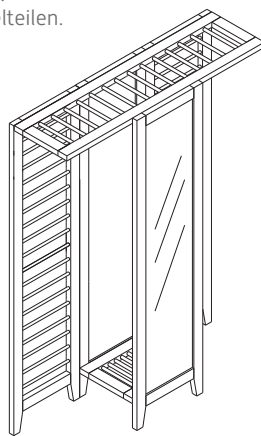

BUTLER 3
BxTxH
150x49x204,4 cm

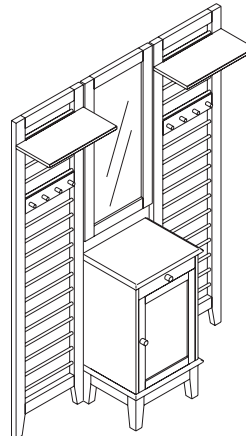

BUTLER 4
BxTxH
150x41,5x204,4 cm

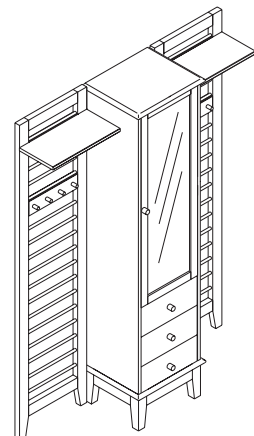

BUTLER 5
BxTxH
150x41,5x204,4 cm

Butler



...EIN TRAUM VON KIEFERMÖBELN...

...mit Liebe zum Detail...



einfach überall...

BUTLER ist ein einfaches und flexibles Aufbewahrungssystem aus massiver Kiefer für die Garderobe, Küche, Wohn-, Bade-, Schlaf- oder Kinderzimmer.

Basisstück ist ein Rippelement woran Kleidungsstücke und Bügel gehängt werden können. Böden- und Hakenelemente können ohne Werkzeug angebracht werden.

BUTLER Elemente werden mit beigefügten Hängeleisten an der Wand befestigt.

Durch variable Montage der Grundelemente, lässt sich das System ganz einfach in jede Raumsituation einpassen.

...zu einer harmonischen Einheit.





IVERSEN INTERIØR

www.iverseninterior.de